

BOBBY BRIX

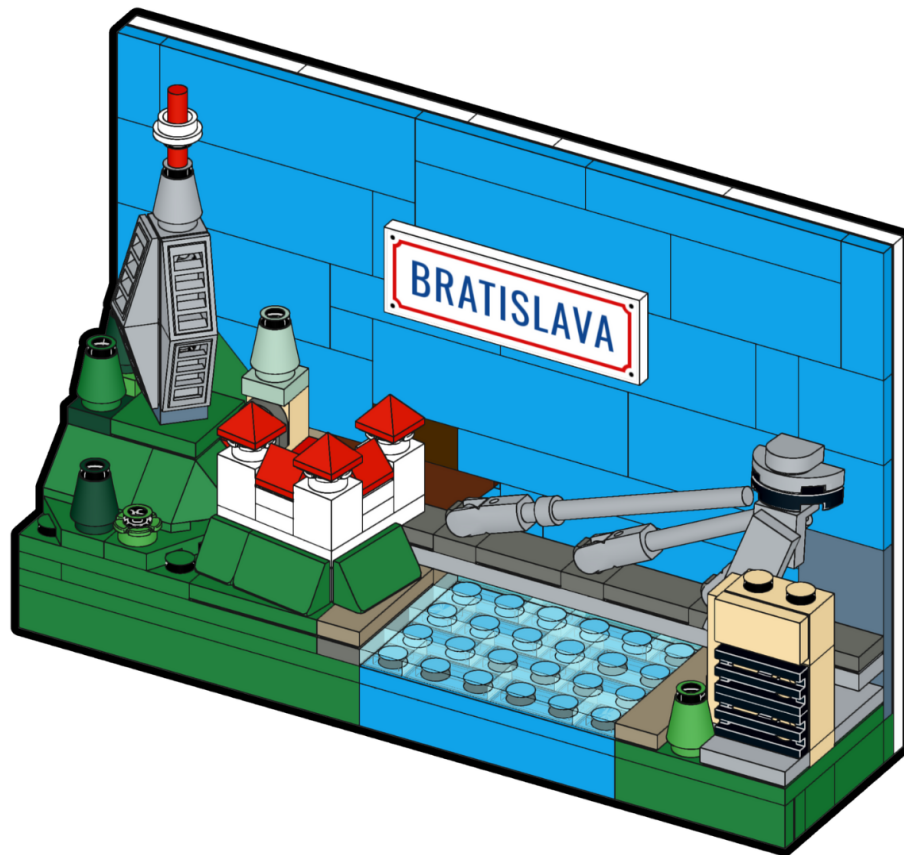

BB-001
MOC #0350

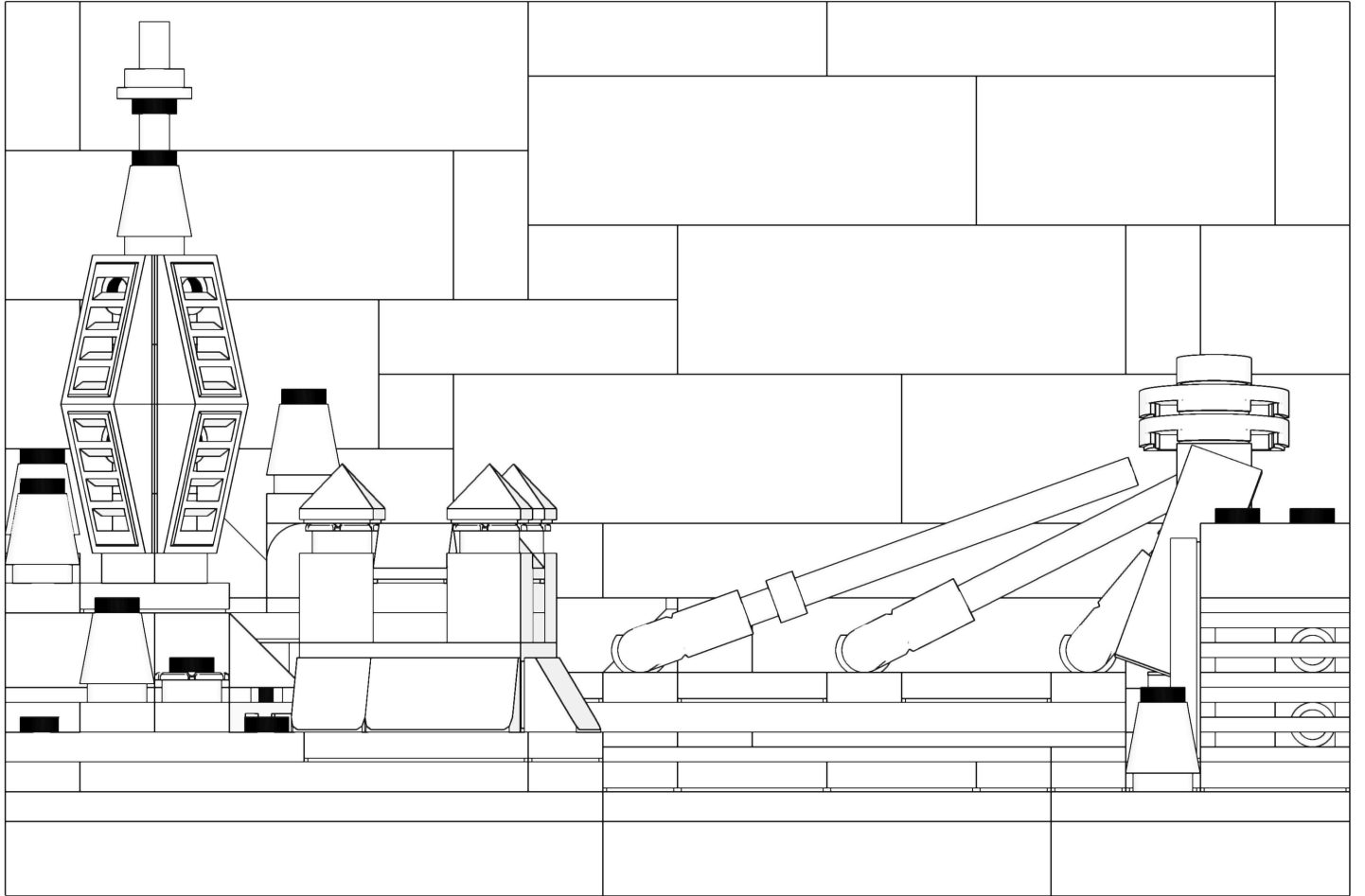

BRATISLAVA

Located on the Danube River at the heart of Europe is the capital city of Slovakia, Bratislava.

It is surrounded by the lush green slopes of the Carpathian Mountains and crowned by the Bratislava Castle overlooking its historic centre.

The old city centre with St. Martin's Cathedral reminds us of the city's rich medieval past, while modern landmarks like the Kamzík TV Tower rise boldly above an ever-evolving skyline. Stretching across the wide blue Danube is one of its most striking sights, the SNP Bridge, which leads toward the Incheba exhibition centre, known for hosting major events and expositions.

Na rieke Dunaj v srdci Európy sa nachádza hlavné mesto Slovenska – Bratislava.

Je obklopené zelenými svahmi Karpát a korunované Bratislavským hradom s výhľadom na historické centrum.

Staré centrum mesta s Katedrálou sv. Martina nám pripomína bohatú stredovekú minulosť mesta, zatiaľ čo moderné pamiatky, ako je televízna veža Kamzík, sa smelo týčia nad neustále sa meniacou panorámou mesta.

Cez široký modrý Dunaj sa tiahne jedna z najvýraznejších dominant, Most SNP, ktorý vedie k výstavisku Incheba, známemu organizovaním významných podujatí a výstav.

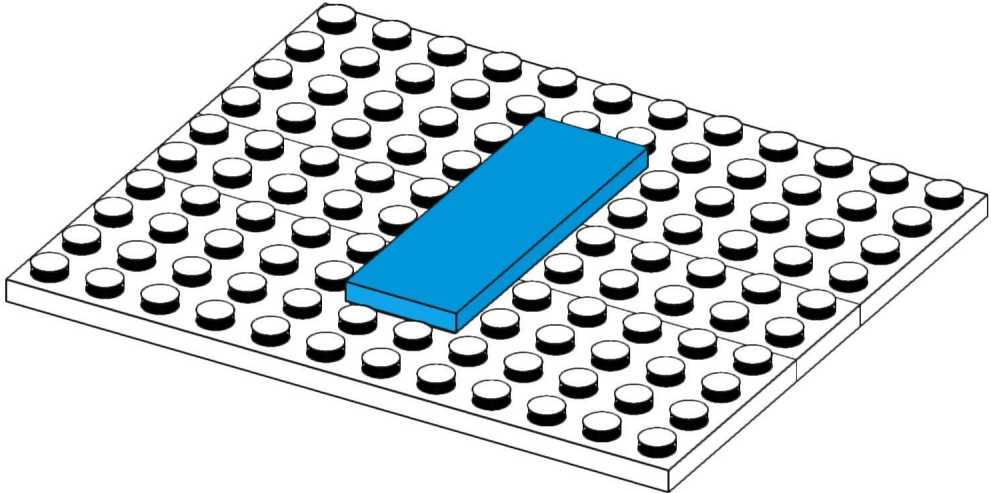
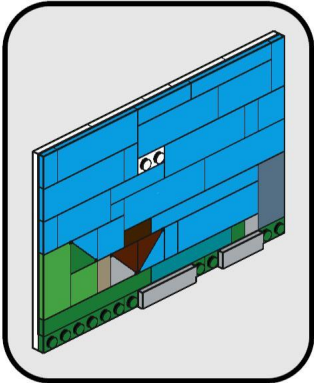
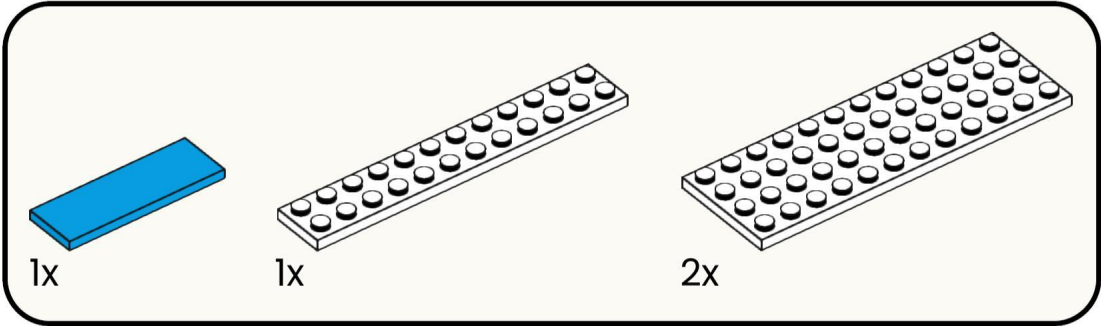

1

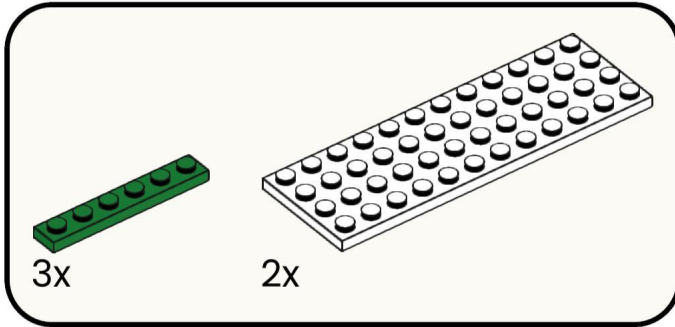

2

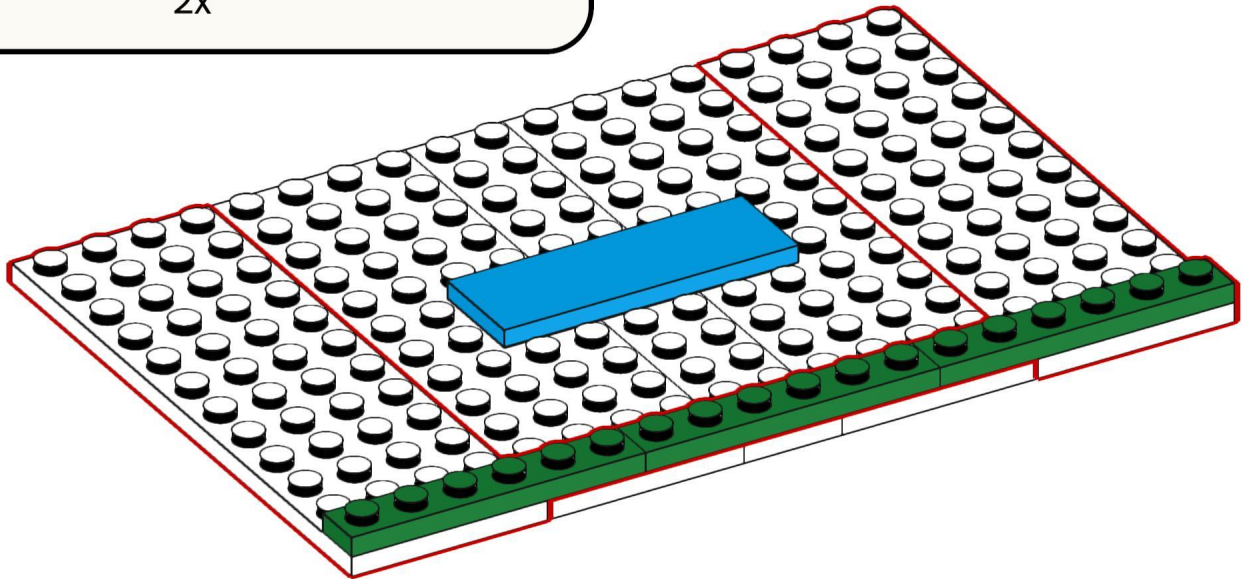

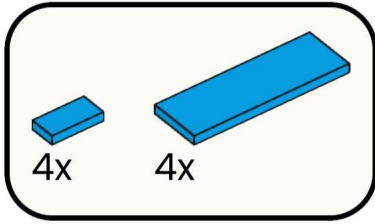

3

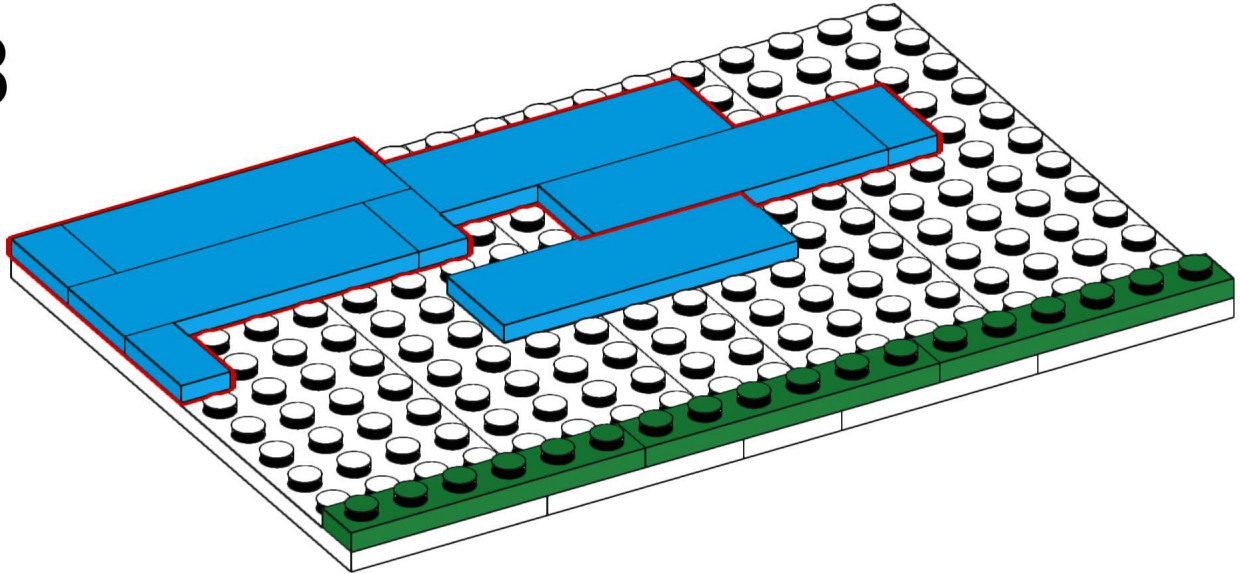

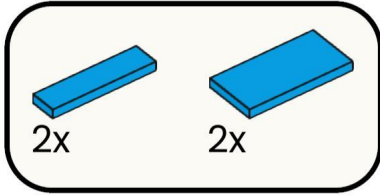

4

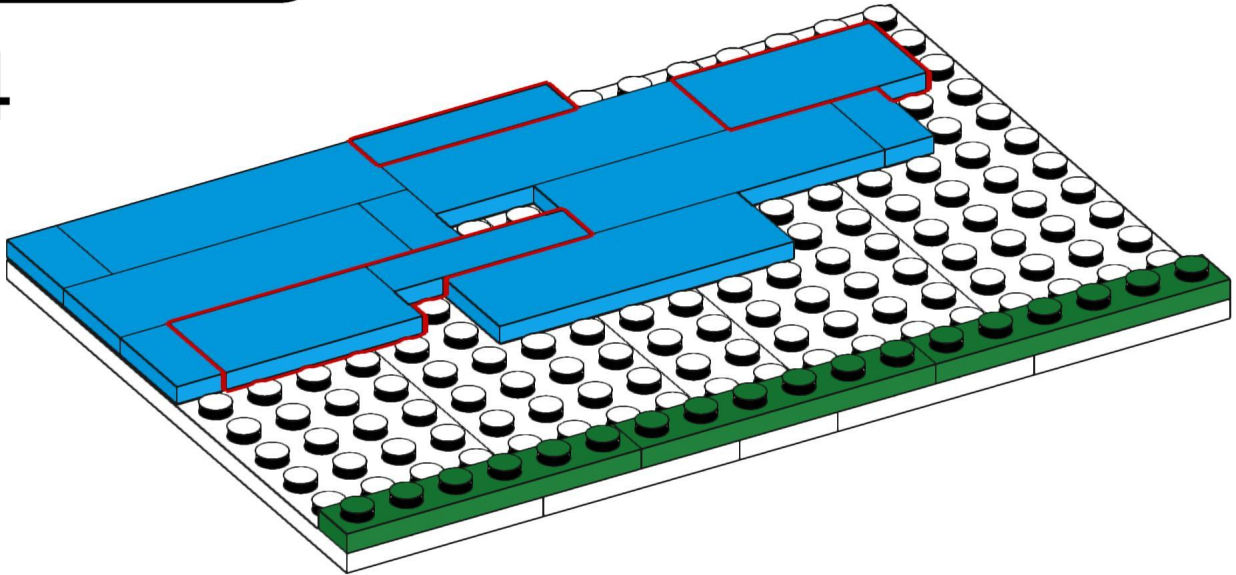

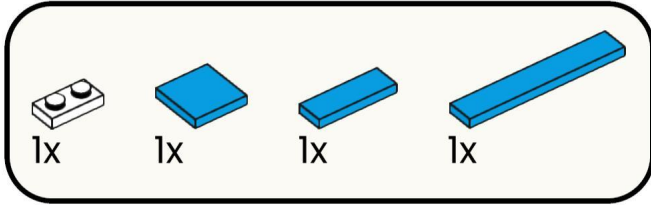

5

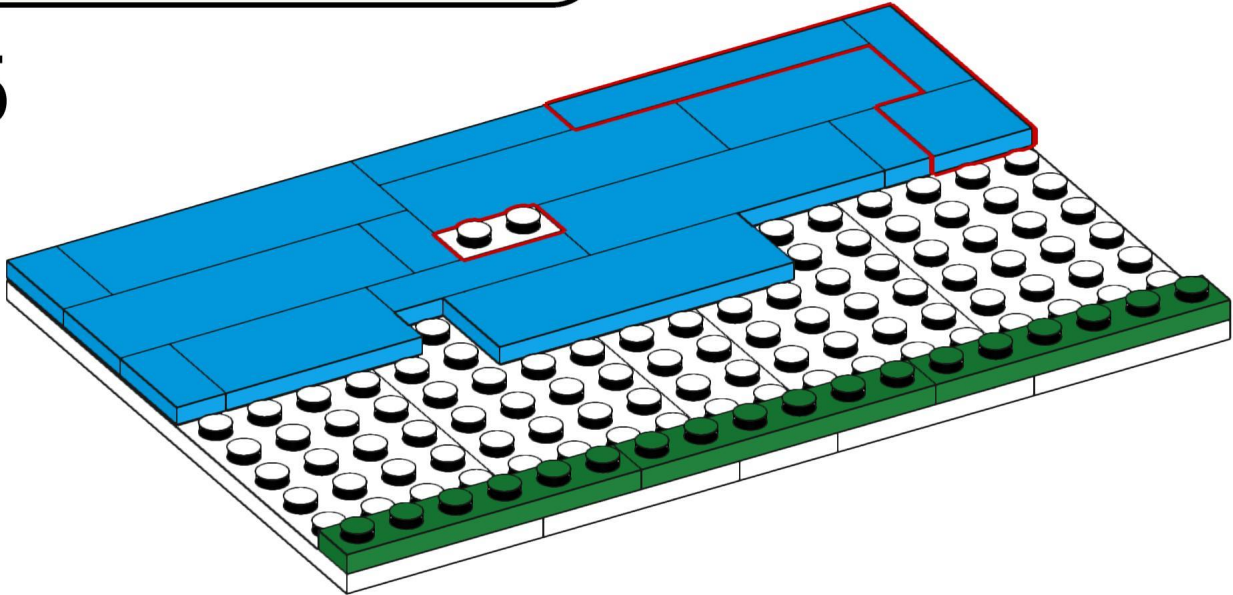

6

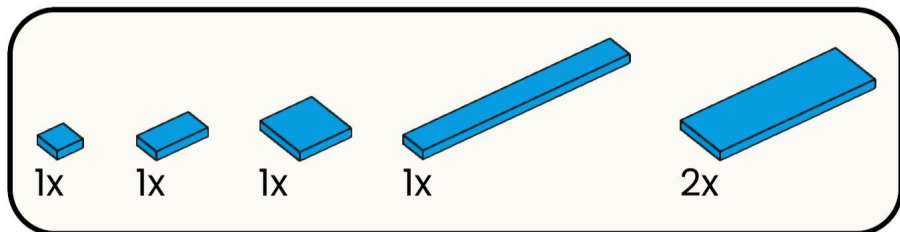

6

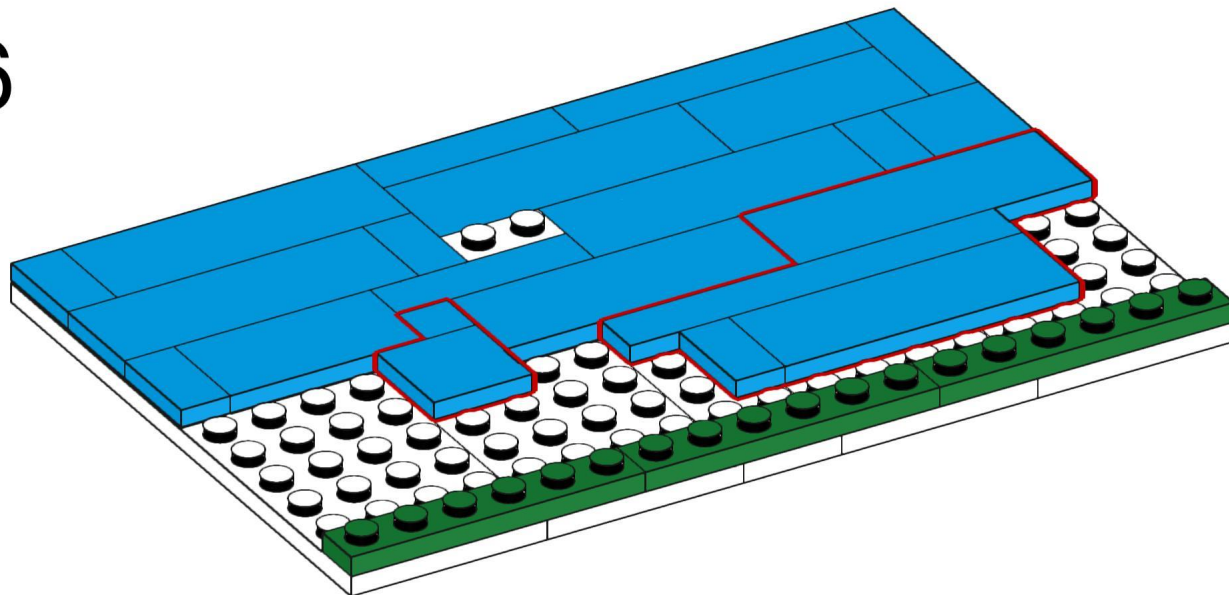

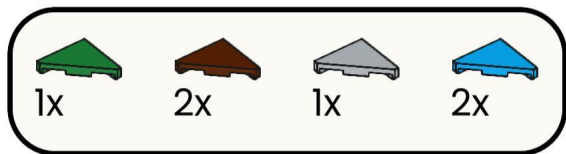

7

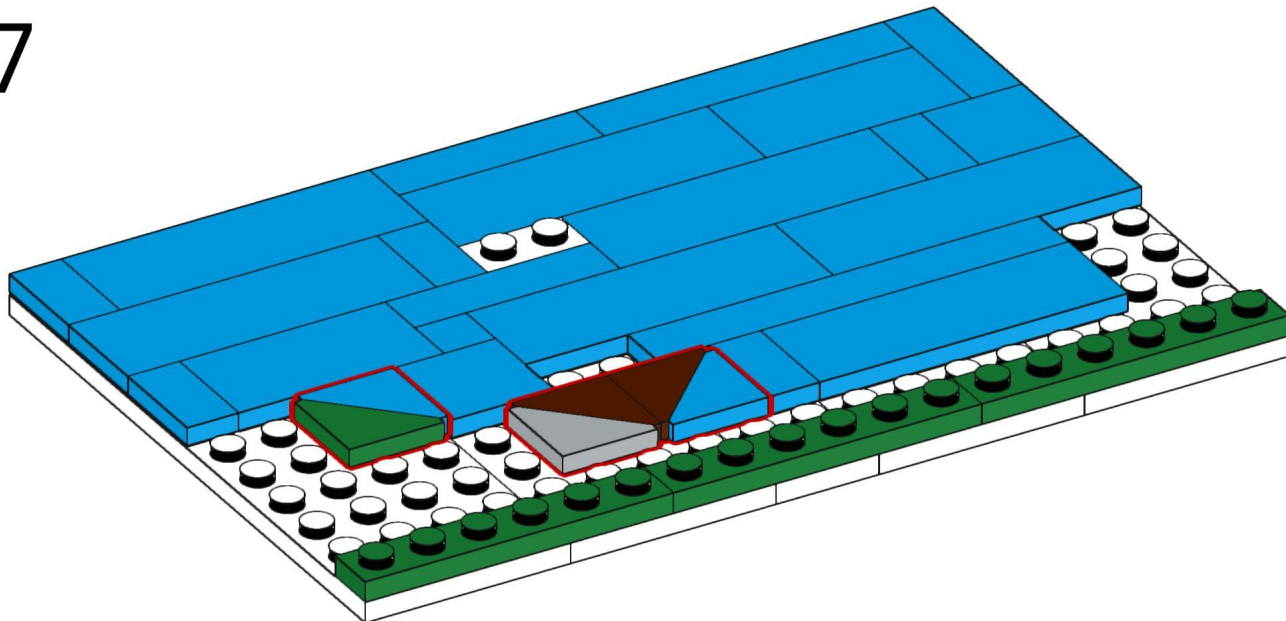

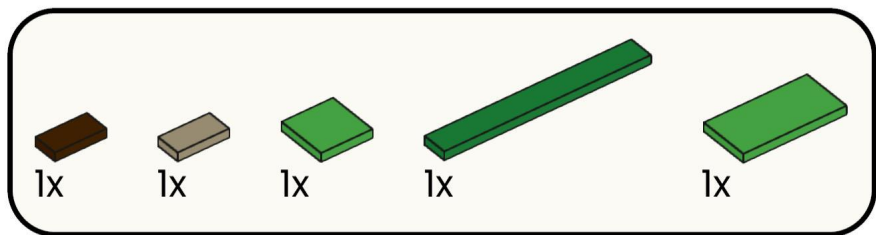

8

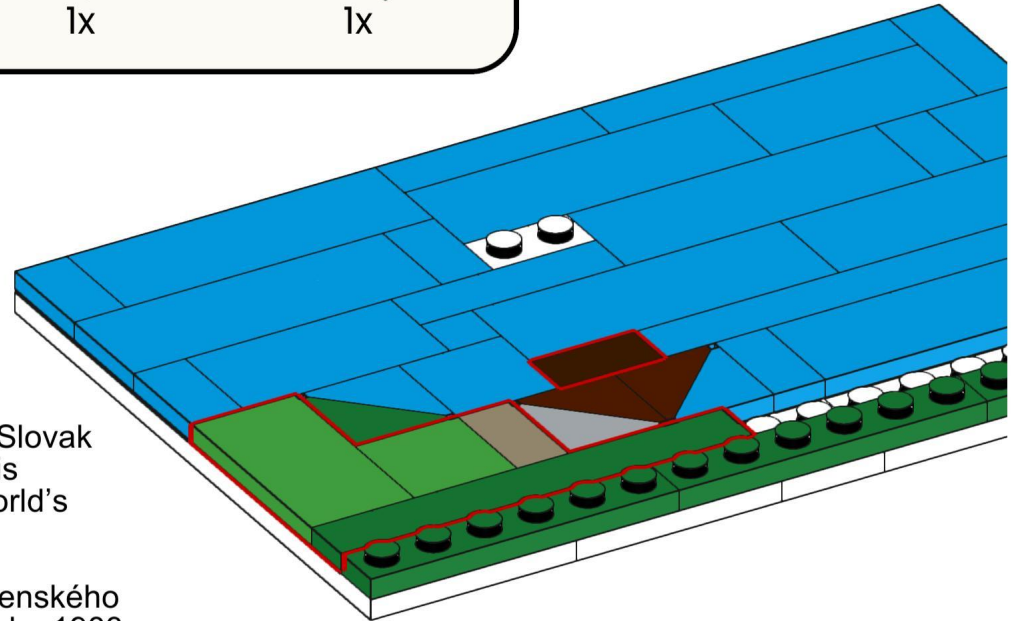

The inverted pyramid of Slovak Radio, finished in 1983, is considered one of the world's most unusual buildings.

Obrátená pyramída Slovenského rozhlasu, dokončená v roku 1983, patrí medzi najnezvyčajnejšie budovy sveta.

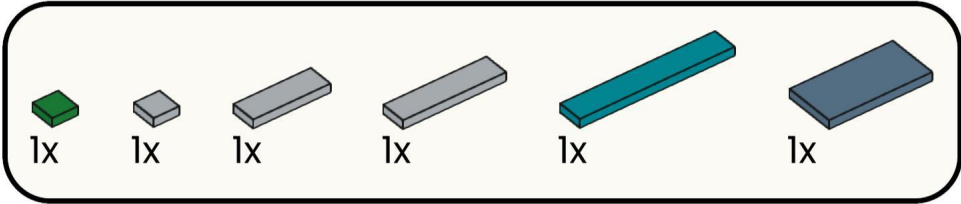

9

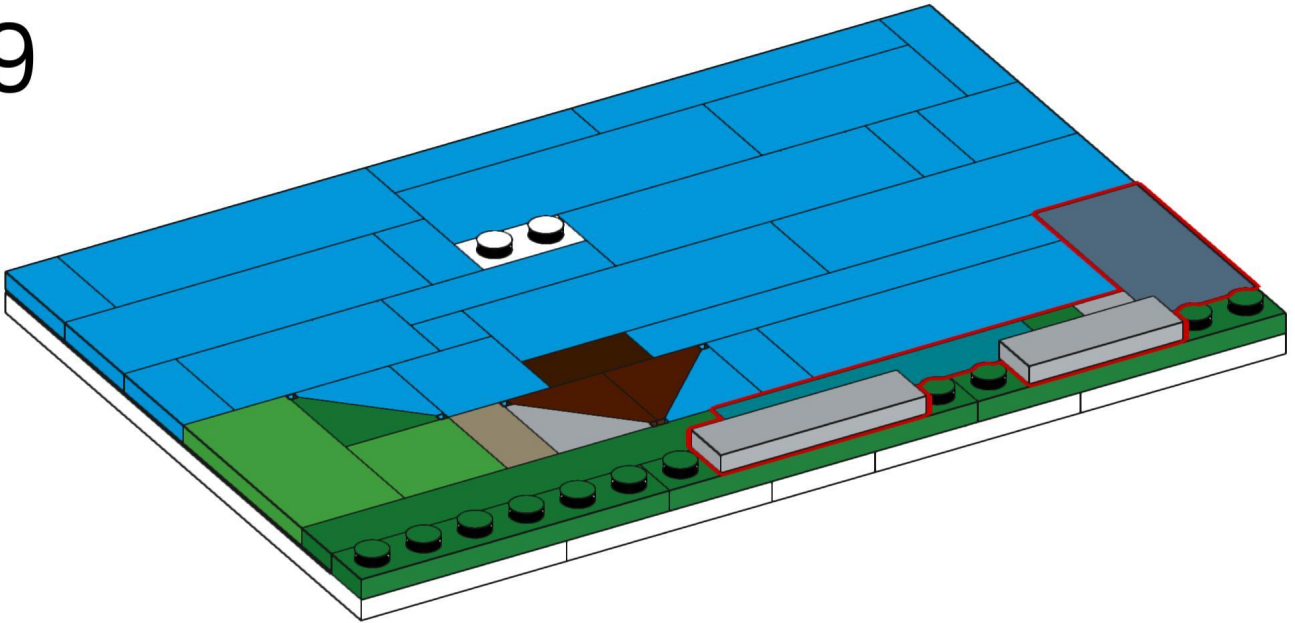

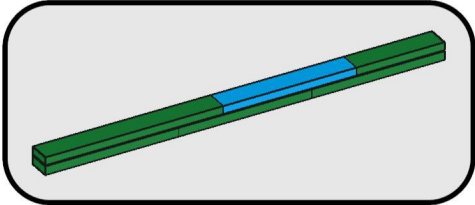
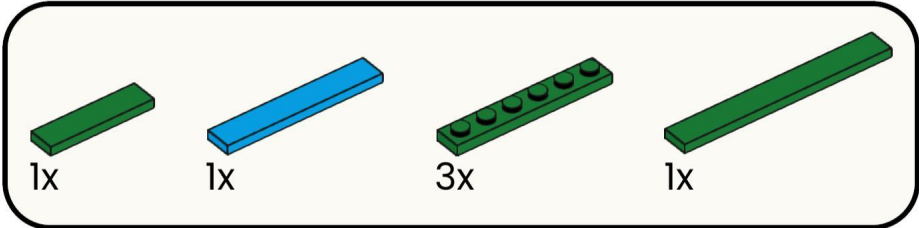

10

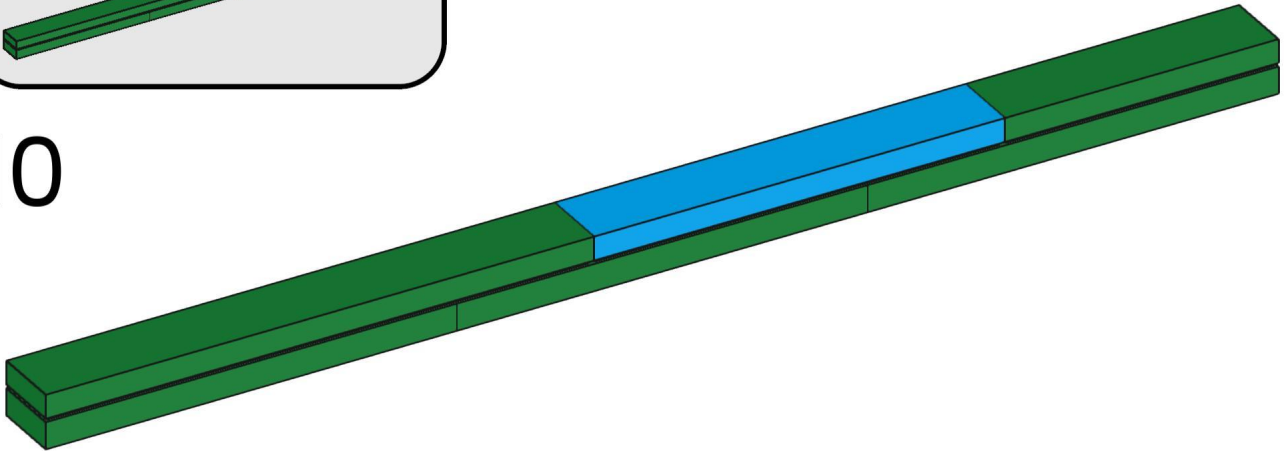

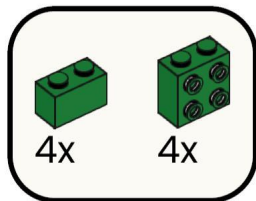

11

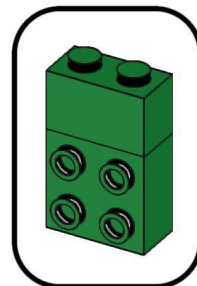
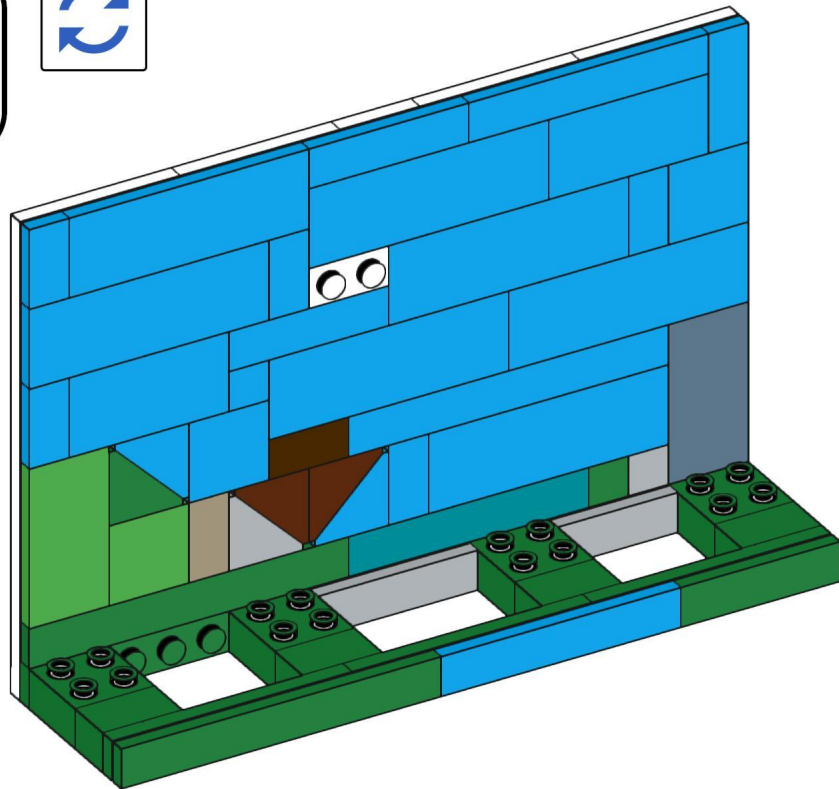

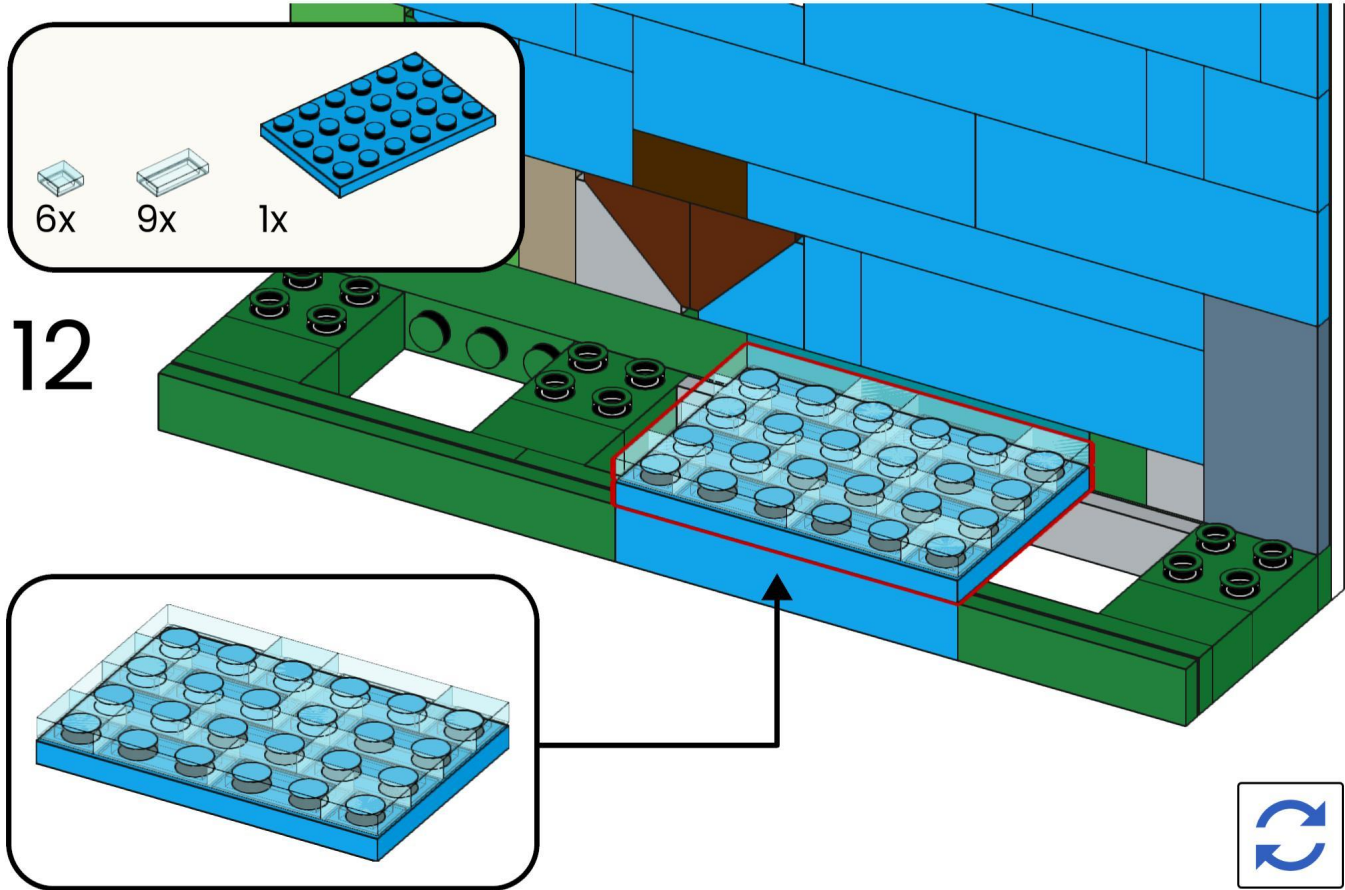

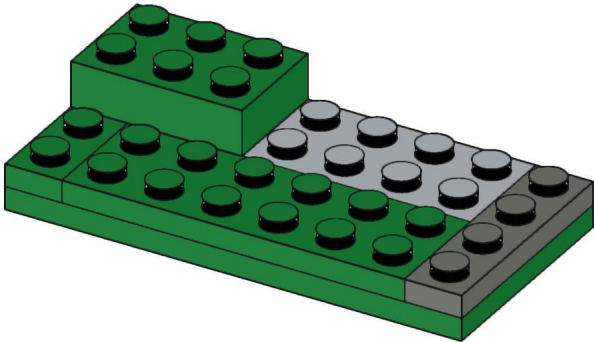
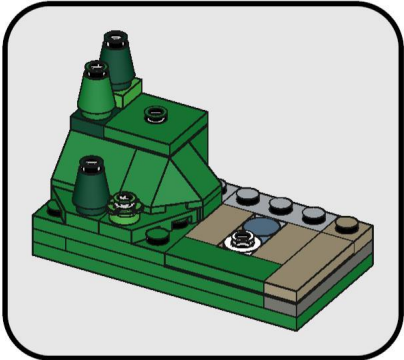
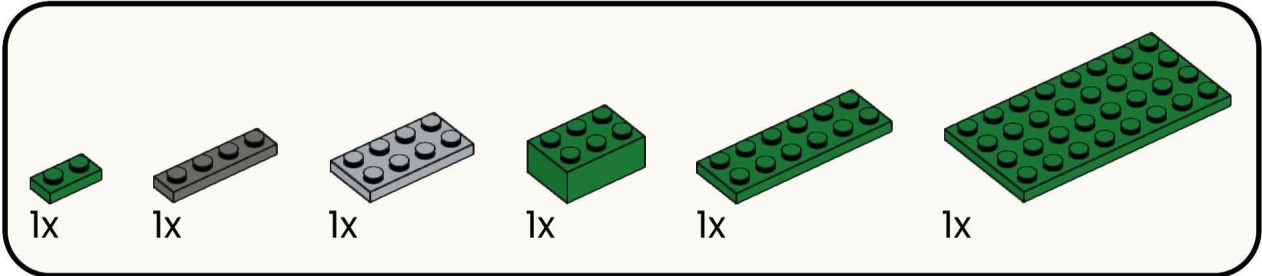

13

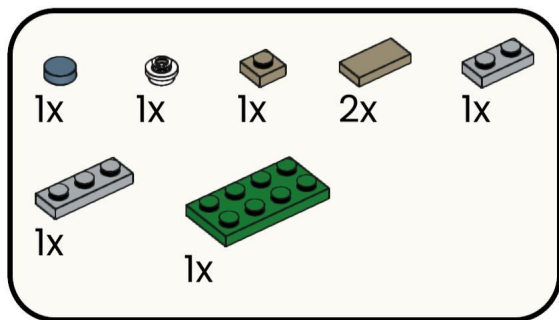

14

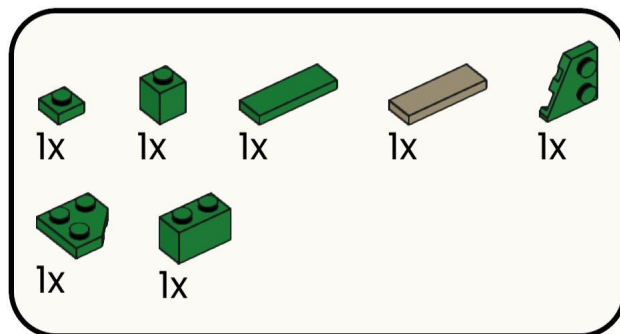
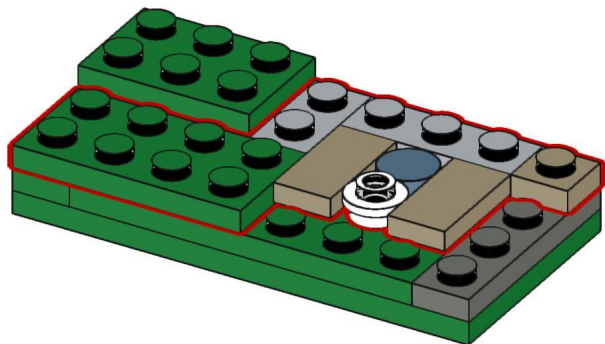

15

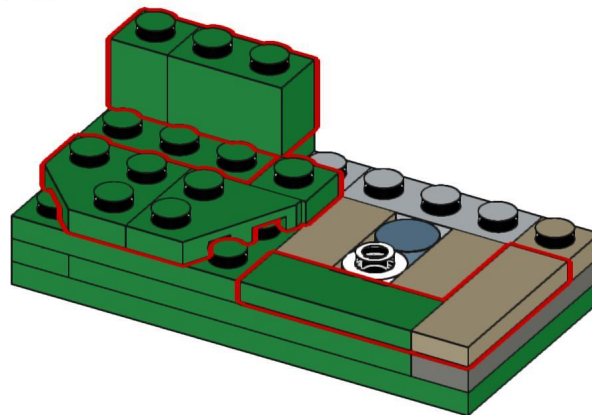

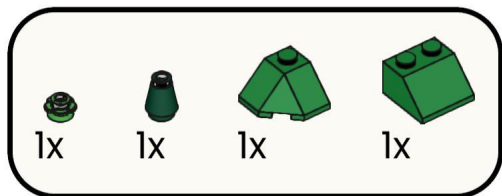

16

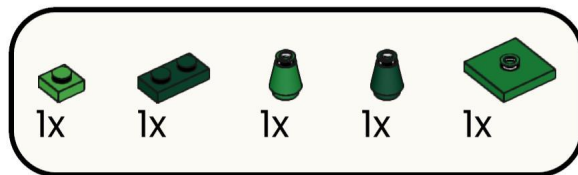
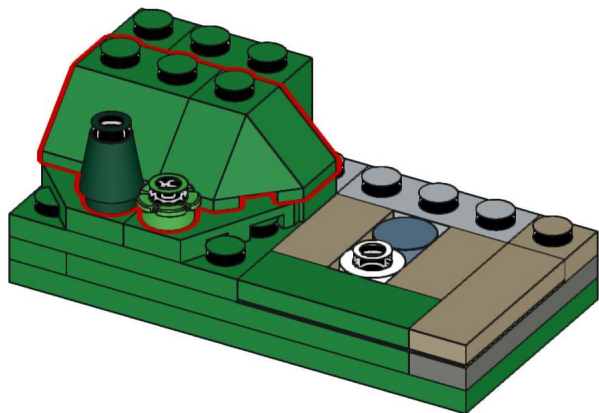

17

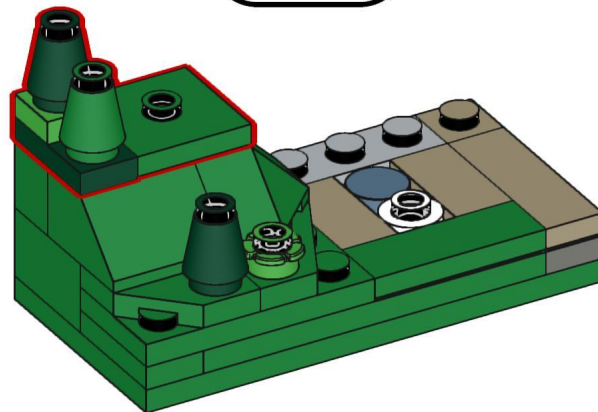
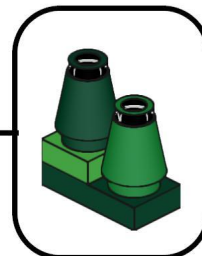

18

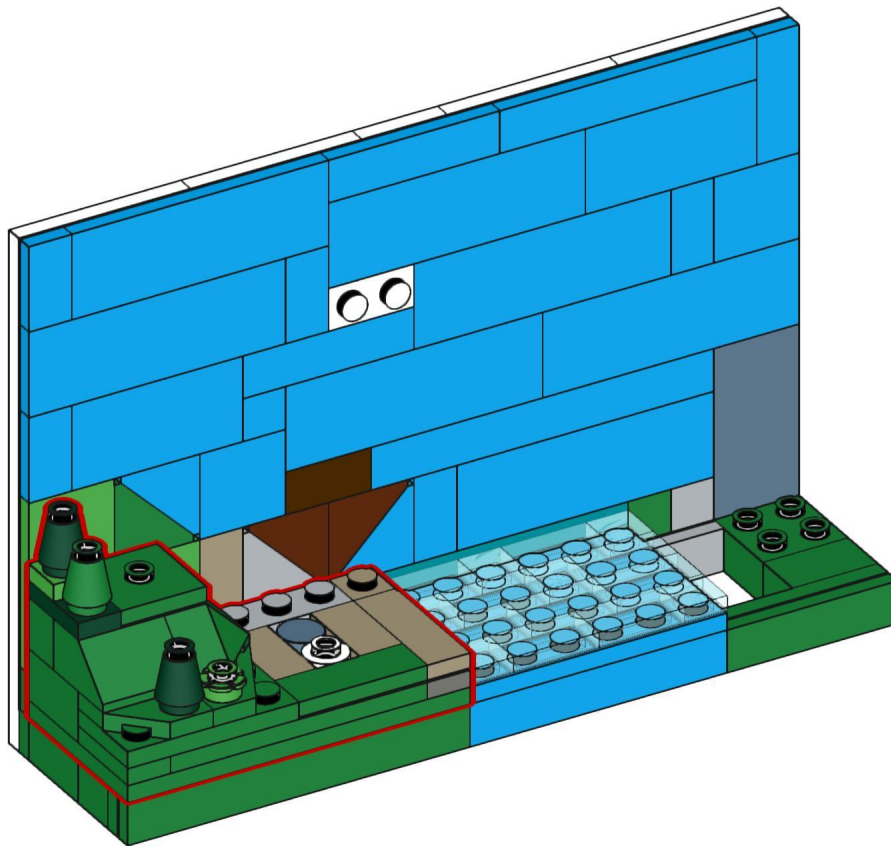



19

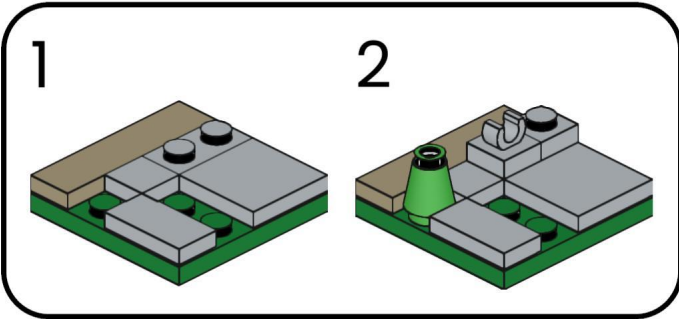
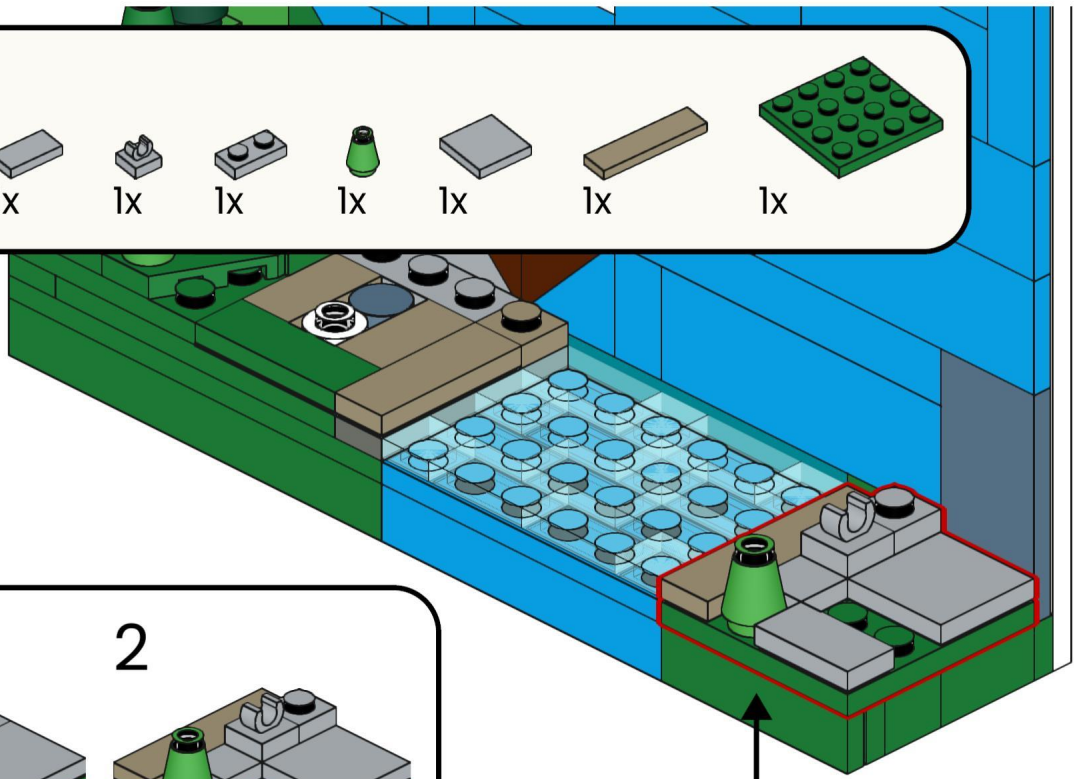

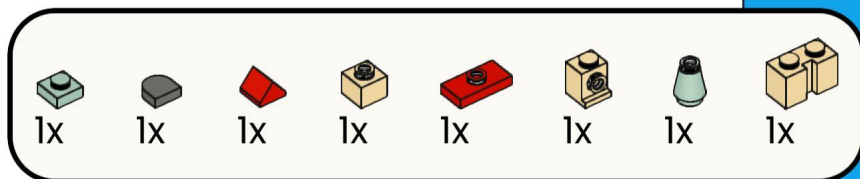

20

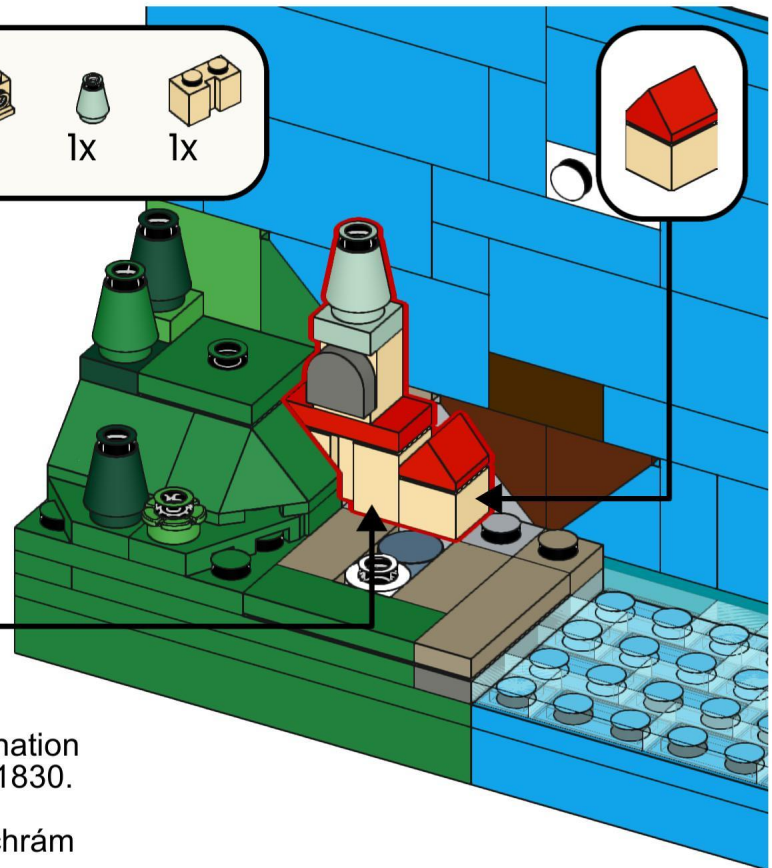
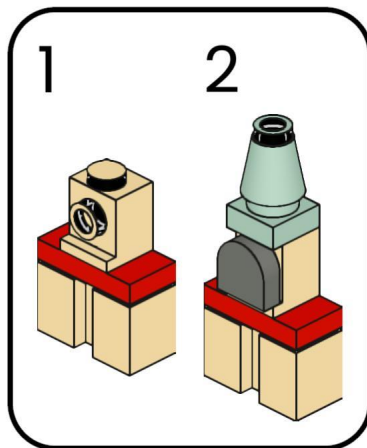

St. Martin's Cathedral served as the coronation church for Hungarian kings from 1563 to 1830.

Dóm sv. Martina slúžil ako korunovačný chrám uhorských kráľov v rokoch 1563 až 1830.

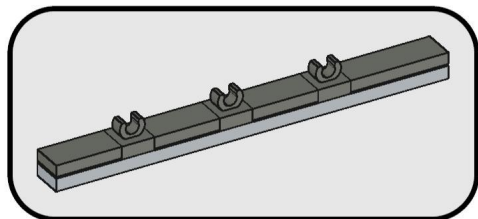
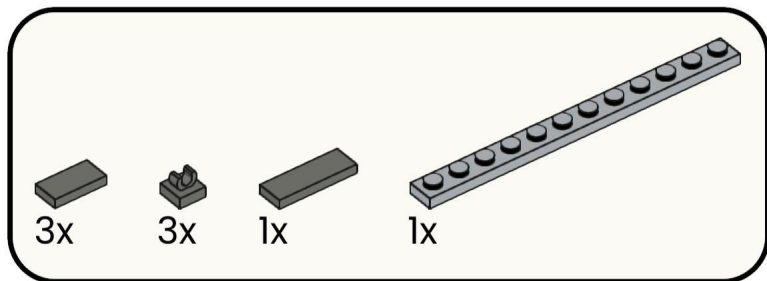

21

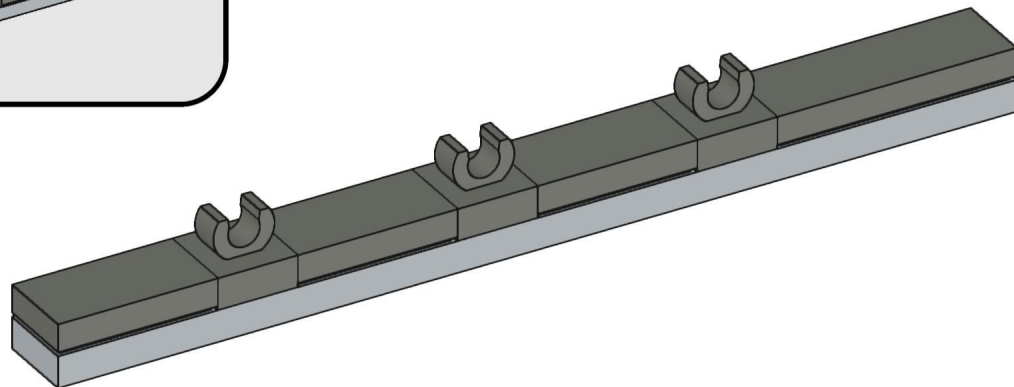

22

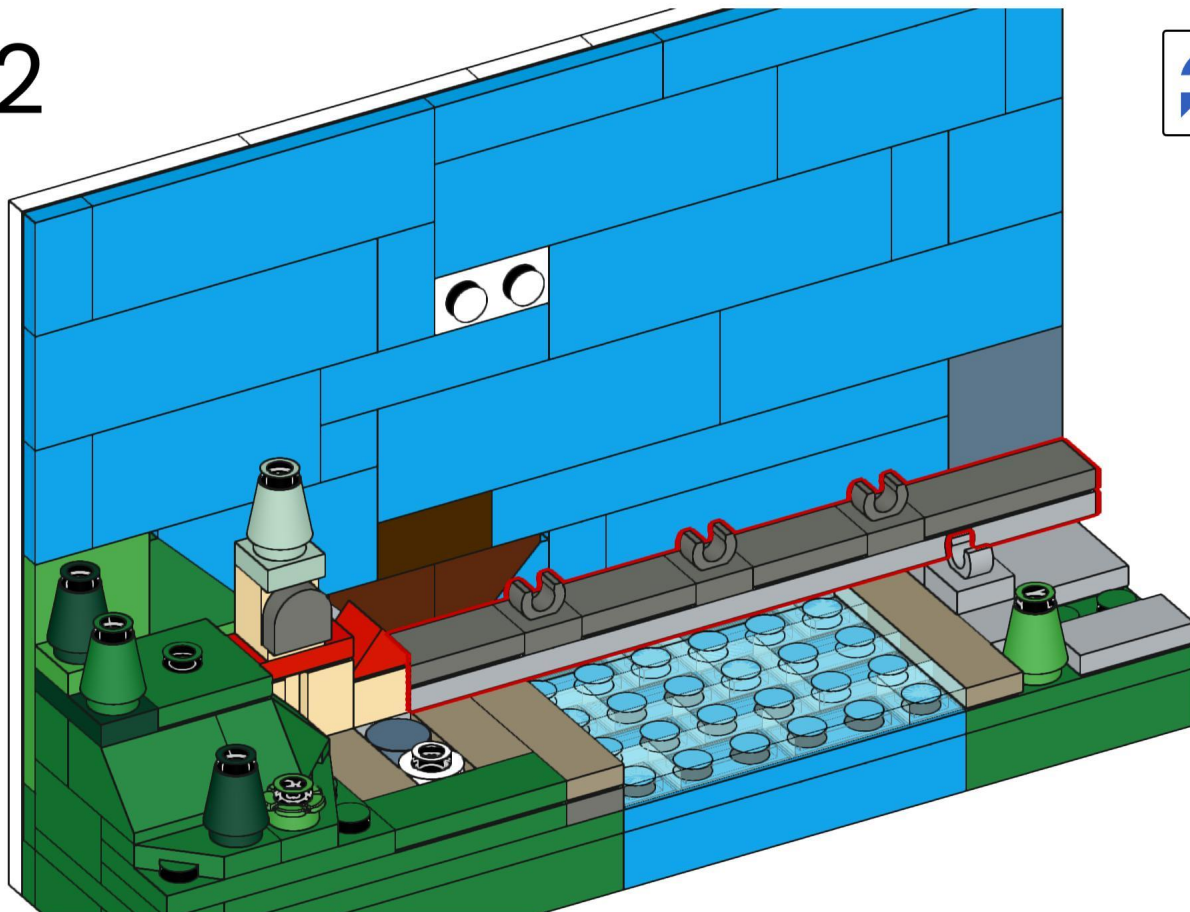

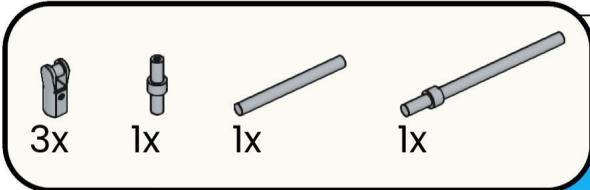

23

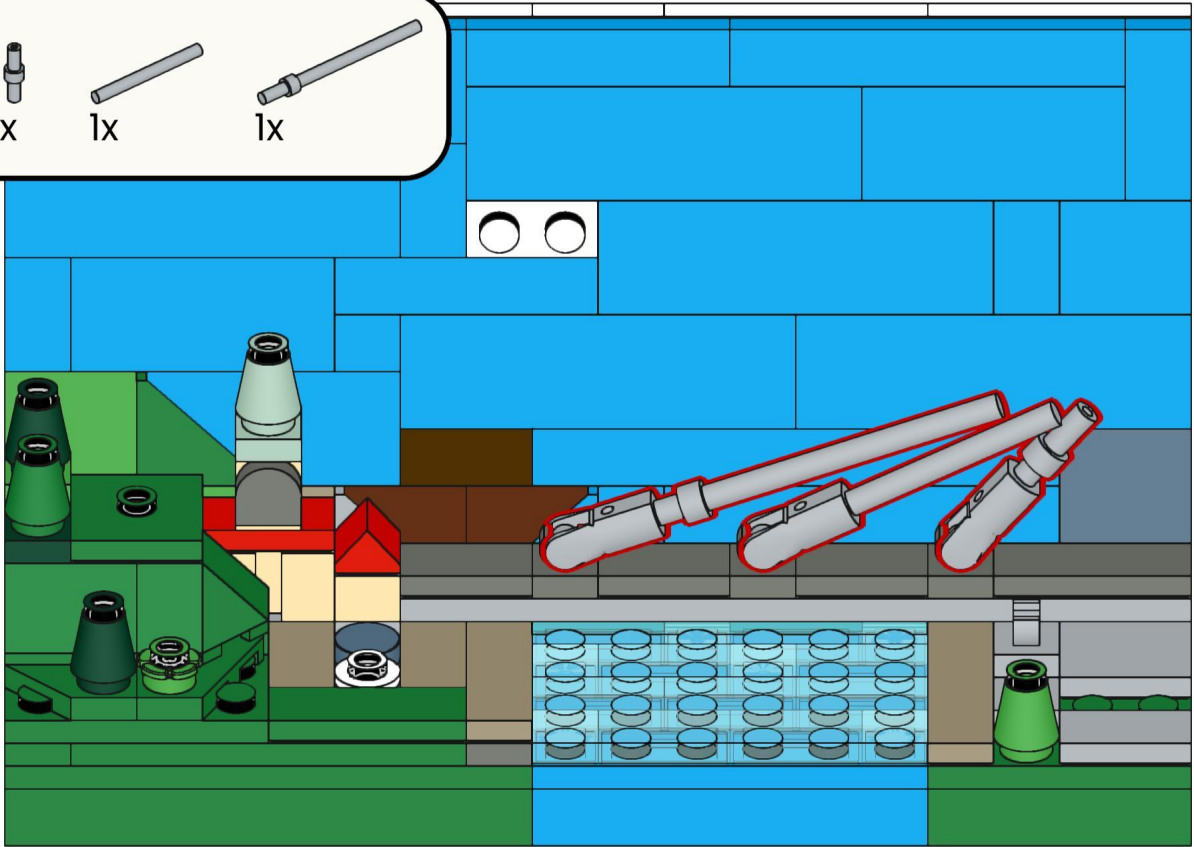

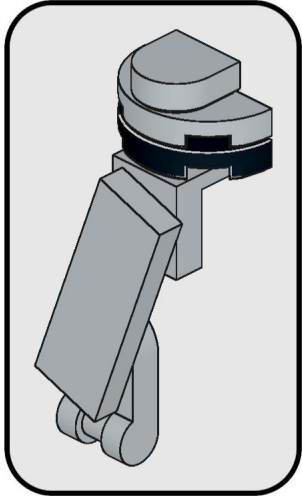
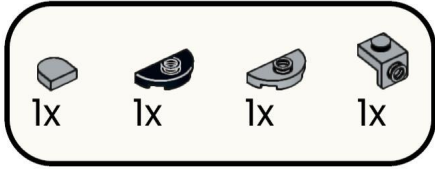

24

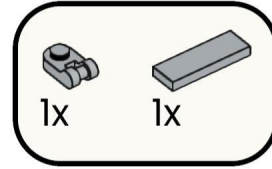
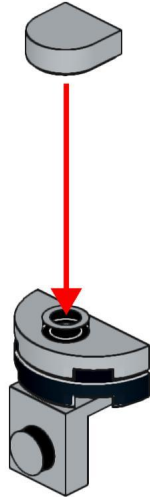

25

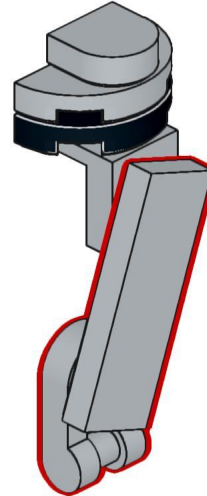

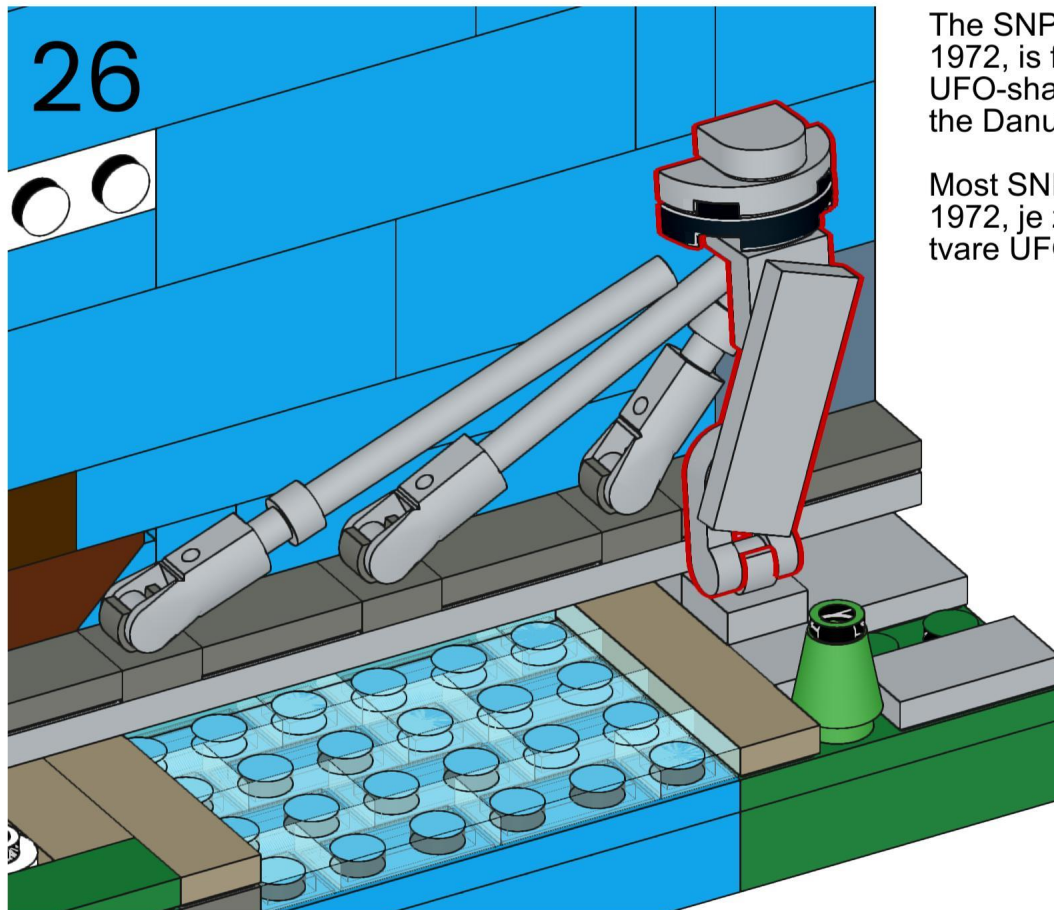

The SNP Bridge, completed in 1972, is famous for its UFO-shaped restaurant above the Danube.

Most SNP, dokončený v roku 1972, je známy reštauráciou v tvare UFO nad Dunajom.



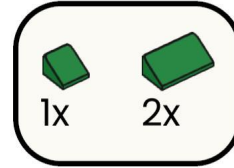
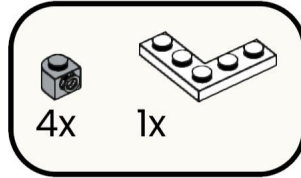
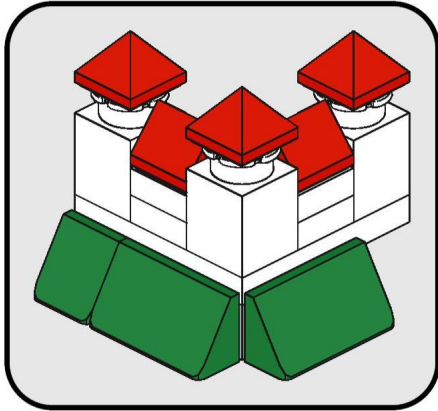

28

27

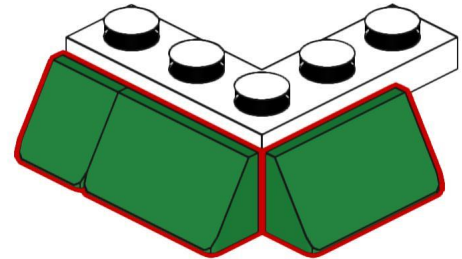
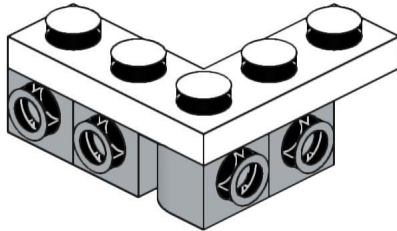

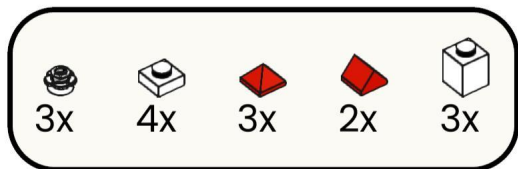

29

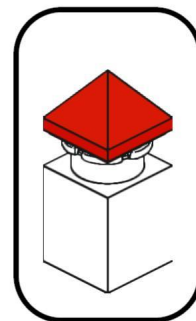
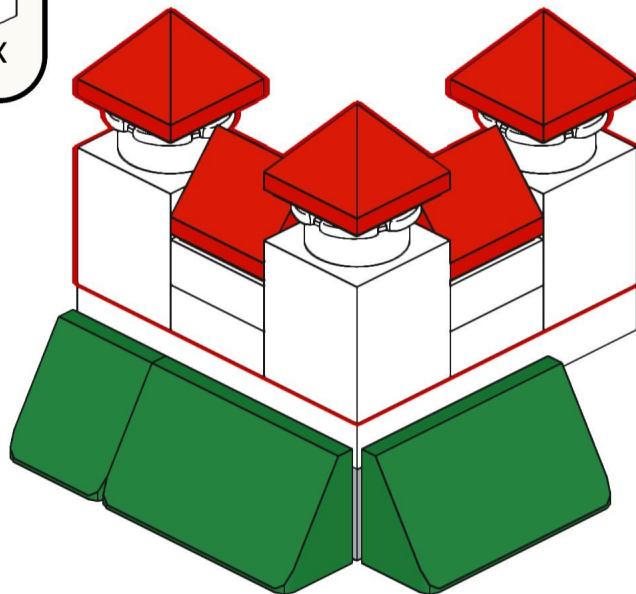

3x

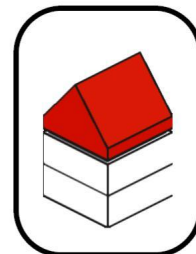

2x

Bratislava Castle has overlooked the Danube for centuries and was rebuilt in the 1950s after a great fire.

Bratislavský hrad stojí nad Dunajom už stáročia a po veľkom požiari bol zrekonštruovaný v 50. rokoch.

30

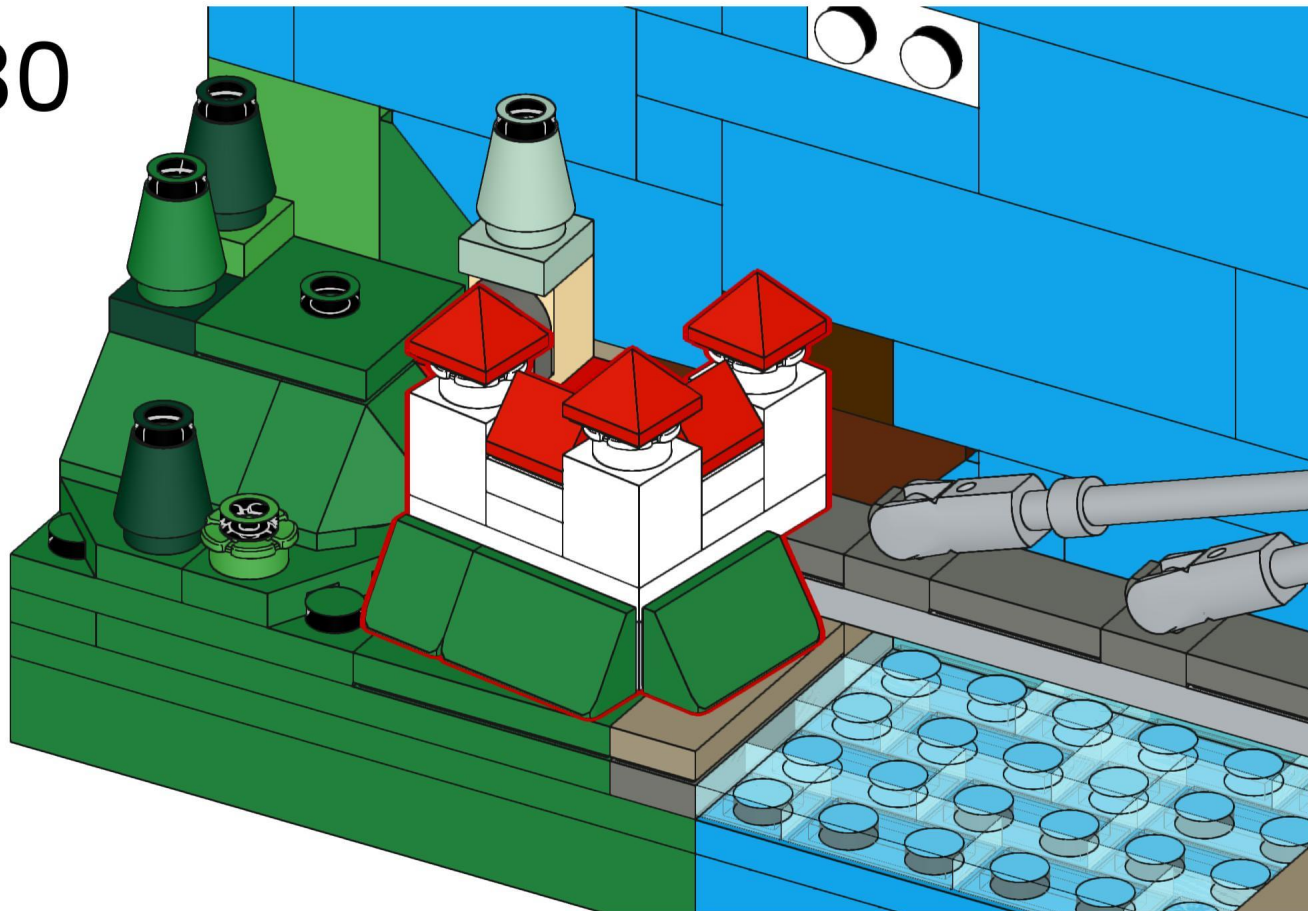

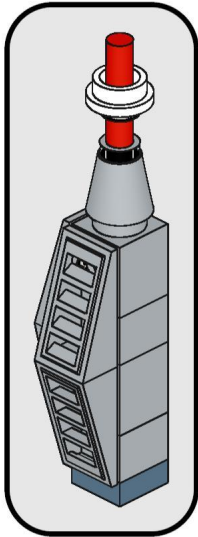
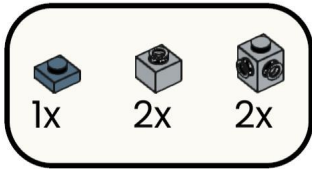

31

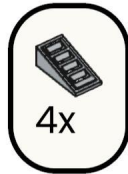
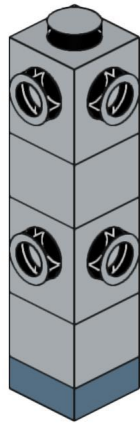

32

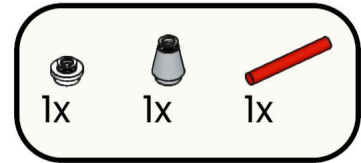
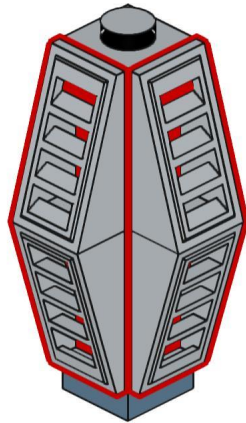

33

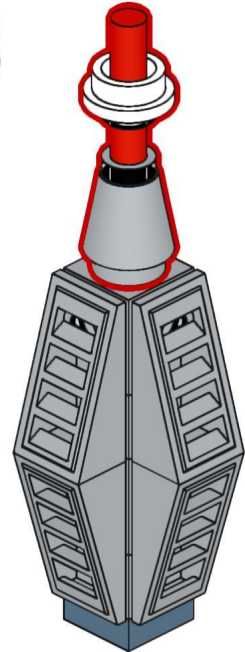

34



The Kamzík TV Tower, built in 1975, is 194 meters tall and offers panoramic views of Bratislava.

Televízna veža na Kamzíku, postavená v roku 1975, meria 194 metrov a ponúka panoramatické výhľady na Bratislavu.



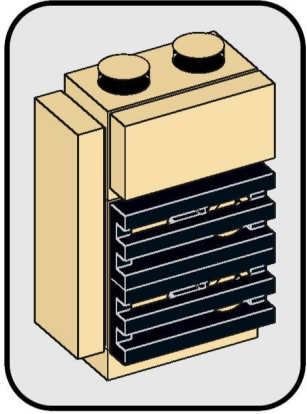
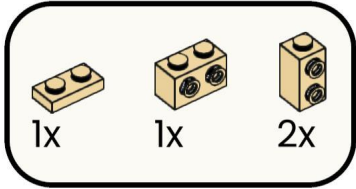

35

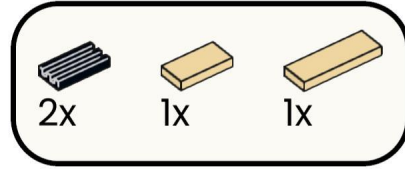
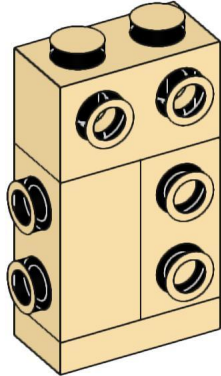

36

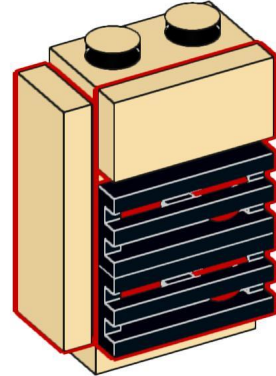

37

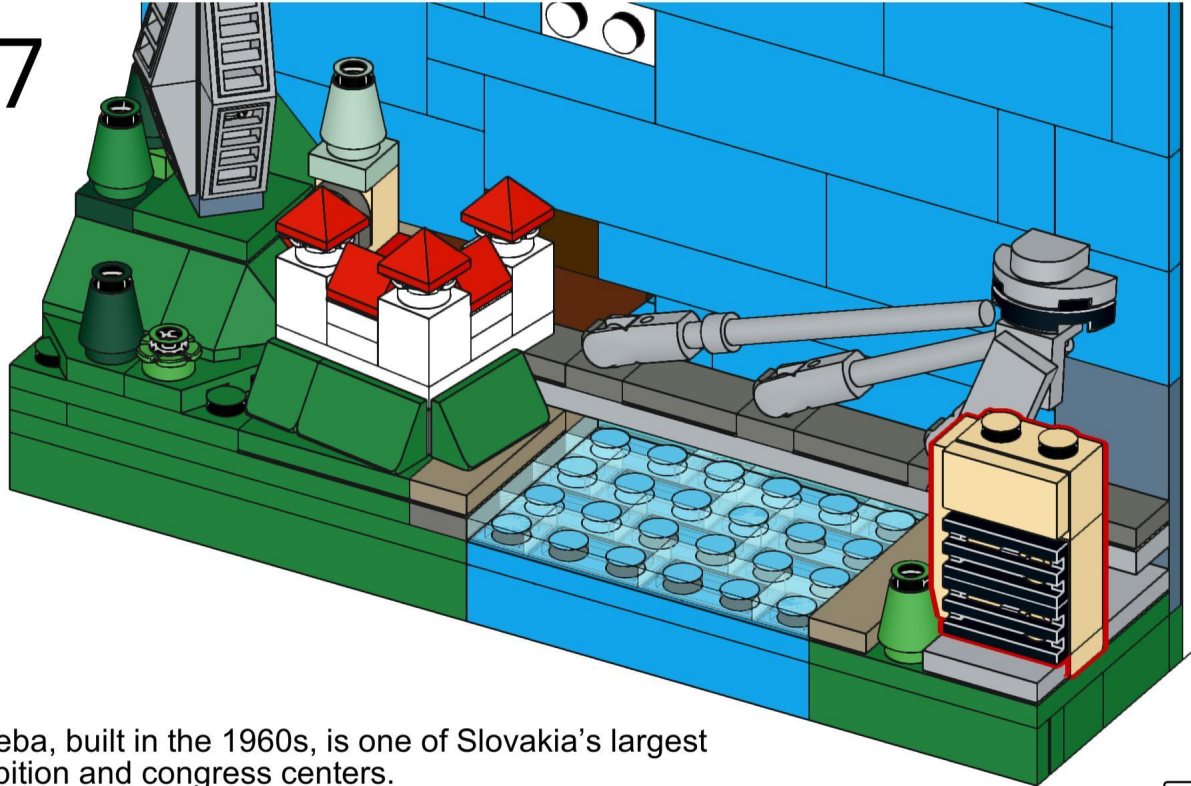

Incheba, built in the 1960s, is one of Slovakia's largest exhibition and congress centers.

Incheba, postavená v 60. rokoch, je jedným z najväčších výstavných a kongresových centier na Slovensku.



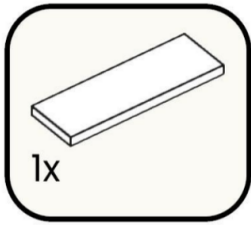

38

BRATISLAVA

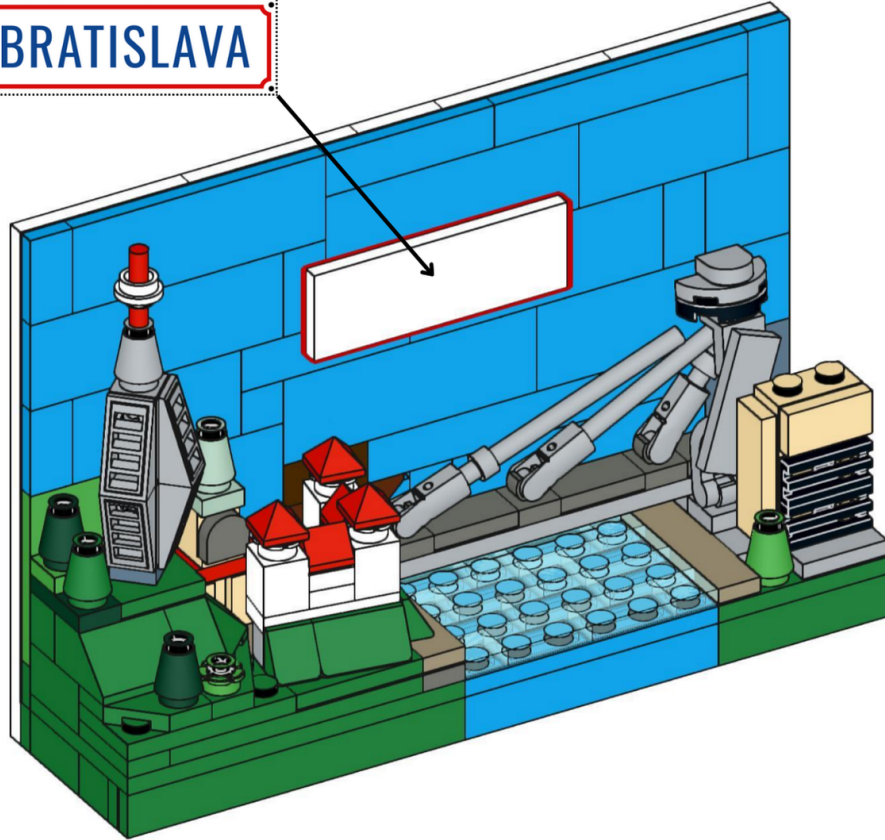

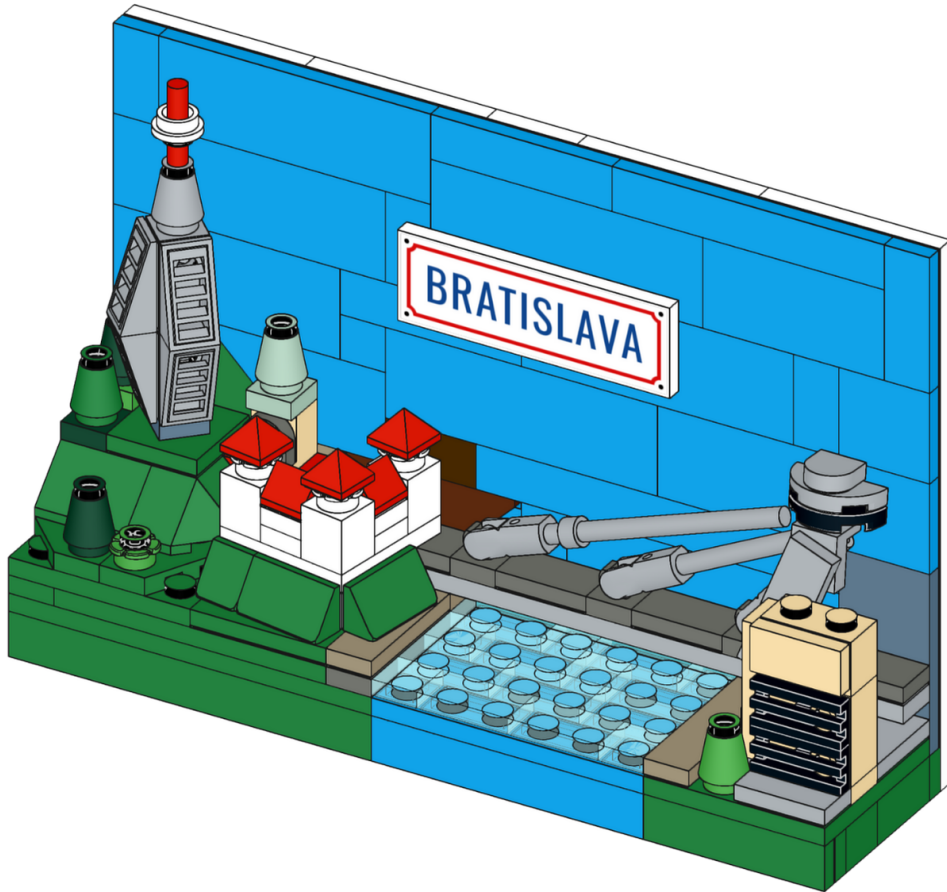



2x



2x



1x



1x

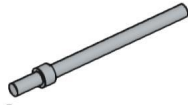

1x



1x



1x



1x



2x

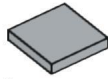

1x



1x



1x



1x

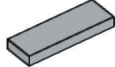

2x



3x



2x



1x



1x

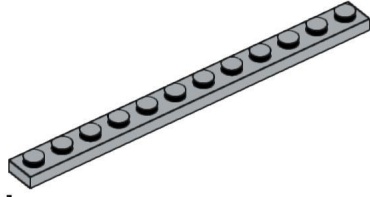

1x

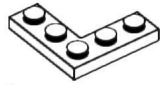

1x



3x



4x



2x



1x



4x

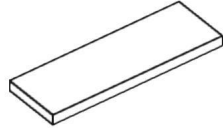

1x



1x



1x



1x

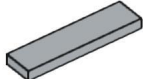

1x



4x



3x



2x

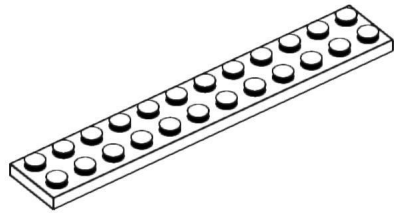

1x



1x



3x



4x



1x



3x



1x



1x

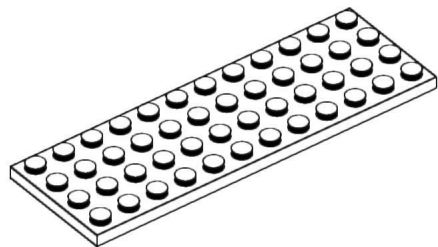

4x



3x



3x



1x



1x



2x



1x



1x



3x



1x



1x



1x



1x



1x



1x



1x



2x



1x



1x



2x



1x



1x



1x



1x



1x



1x



1x



2x



5x



1x



1x



1x



1x



1x



4x



1x



1x



1x



1x



1x

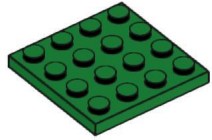

1x

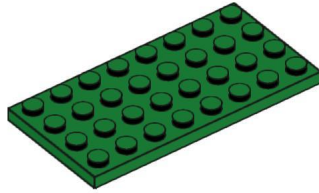

1x



1x

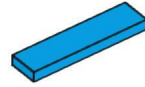

2x

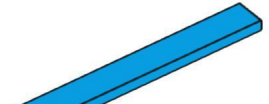

1x

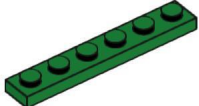

6x



1x



1x



2x

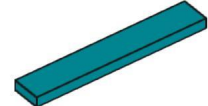

1x

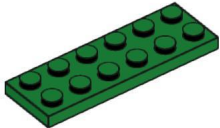

1x



1x



1x

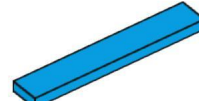

2x



1x

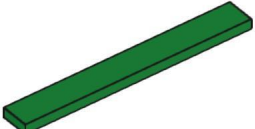

2x



1x



5x

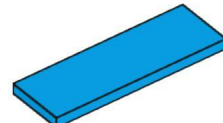

7x



1x



1x



1x



2x



2x

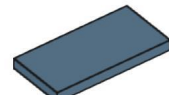

1x

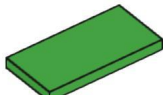

1x



1x

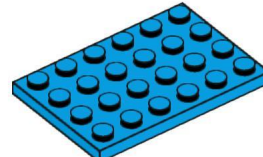

1x



6x



9x



LEAVE A REVIEW!

We'd love to hear your thoughts!

NAPÍŠTE RECENZIU!

Radi si prečítame Váš názor!

Take a look at our other MOC Kits! | Pozrite si naše ďalšie MOC stavebnice!



KAMZÍKOVA VEŽA

GB-002



BRATISLAVSKÝ HRAD

GB-003



**BUDOVA SLOVENSKEHO
ROZHLASU + MOST SNP**

GB-004

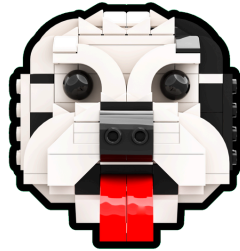

Building instructions and model designed by The Bobby Brix Channel.
This is a custom MOC set using genuine LEGO® parts. For questions or support, visit www.bobbybrix.com.

LEGO® is a trademark of the LEGO Group, which does not sponsor, authorize, or endorse this product.

© 2025 The Bobby Brix Channel. All rights reserved.