

# BOBBY BRIX

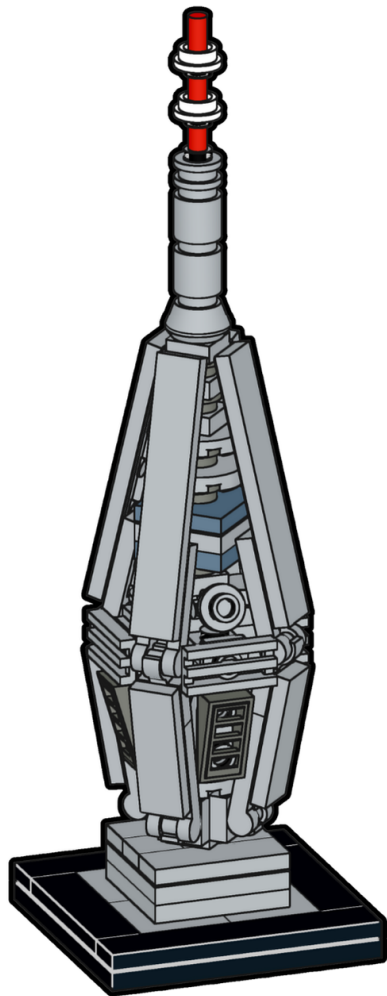

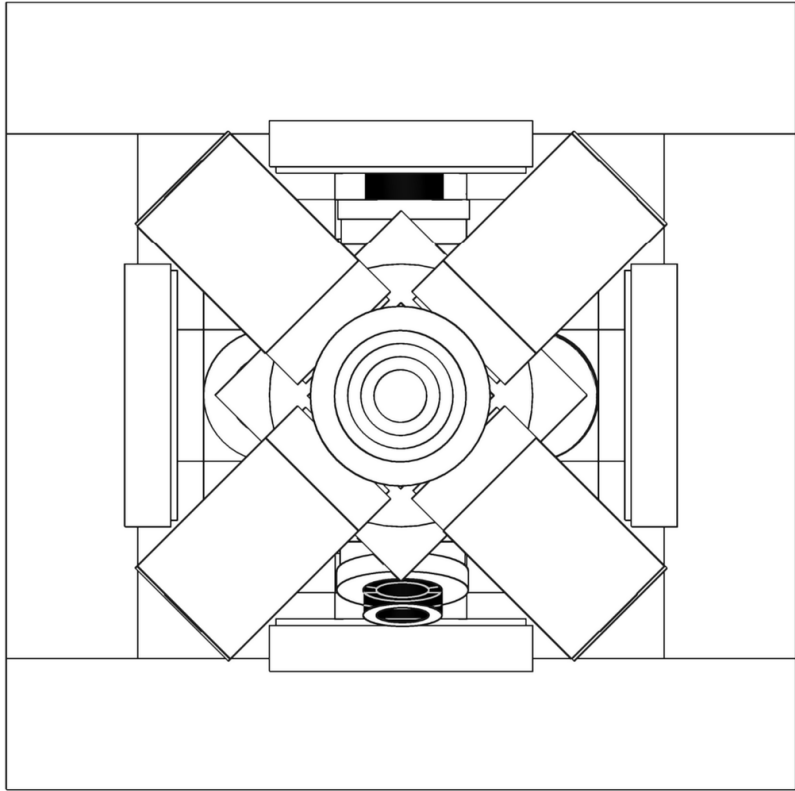

# TELEVÍZNA VEŽA NA KAMZÍKU

— BRATISLAVA KAMZIK TV TOWER —

Televízna veža na Kamzíku stojí na vrchu Kamzík v Malých Karpatoch nad Bratislavou a slúži ako hlavný rozhlasový a televízny vysielateľ mesta.

Výstavba sa začala v roku 1967 a bola dokončená v roku 1975 pod vedením architektov Stanislava Májeka, Jakuba Tomašáka, Juraja Kozáka, Milana Juricu a Jána Privitzera.

So svojou výškou 194 metrov nad nadmorskou výškou kopca 433 metrov spája konštrukcia železobetónové jadro s trojuholníkovým ocelovým rámom, ktorý nesie anténne systémy.

Okrem technickej funkcie obsahuje veža aj vyhladkovú úroveň a reštauračné priestory, čím sa stala významnou súčasťou bratislavskej panorámy.

The Kamzík TV Tower stands on Kamzík Hill in the Little Carpathians above Bratislava, serving as the city's main radio and television transmitter.

Construction began in 1967 and finished in 1975 under the direction of architects Stanislav Májek, Jakub Tomašák, Juraj Kozák, Milan Jurica, and Ján Privitzer.

Rising 194 meters above the hill's 433-meter elevation, the structure combines a reinforced concrete core with a triangular steel frame used to support its antenna systems.

Beyond its technical function, the tower includes an observation level and restaurant space, making it both an engineering landmark and a practical part of the city's skyline.

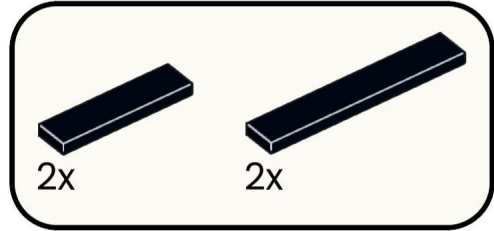
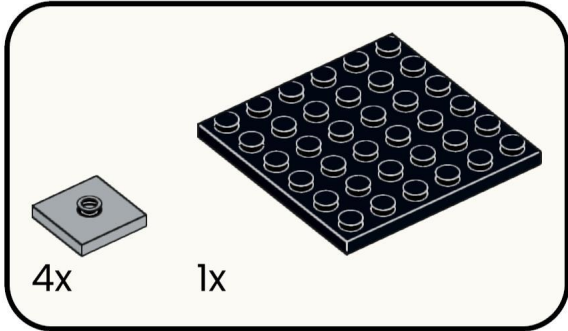

2

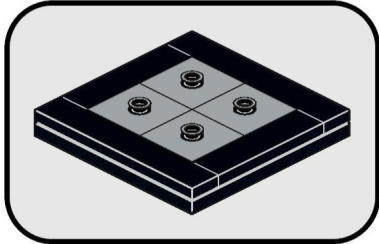

1

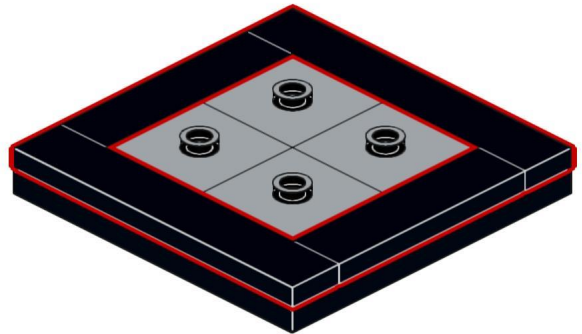
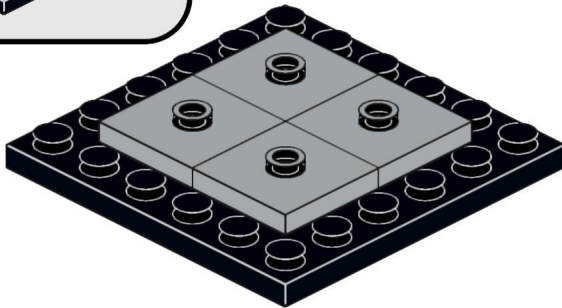

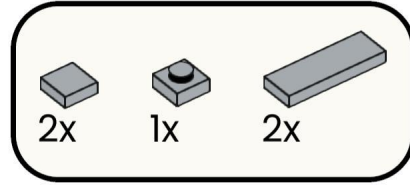
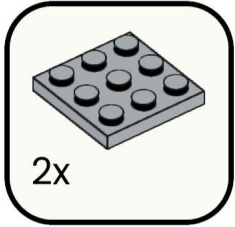

4

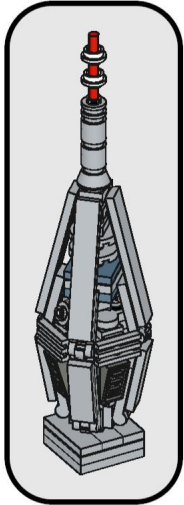

3

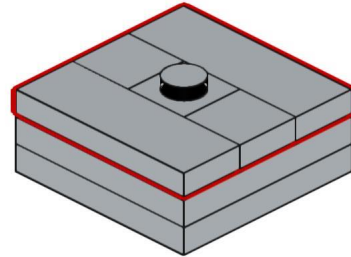
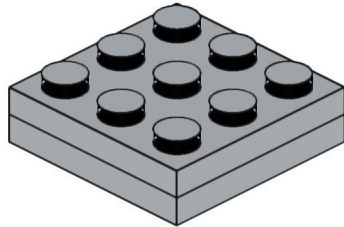

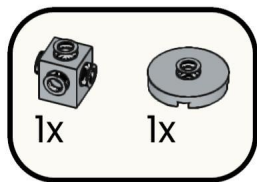

5

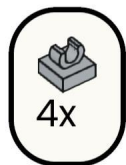
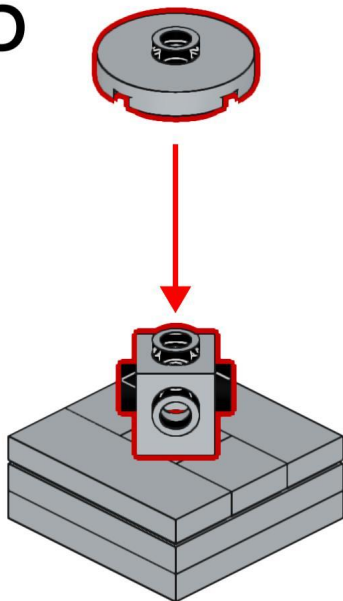

6

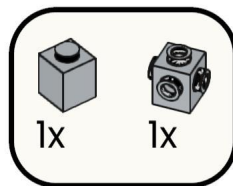
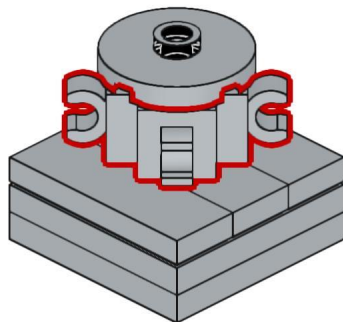

7

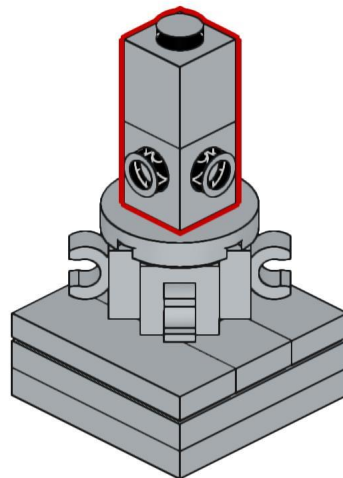

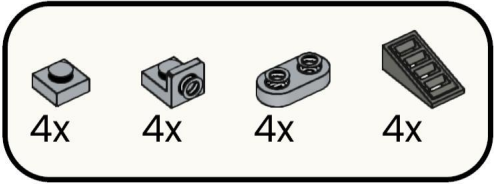

8

4x

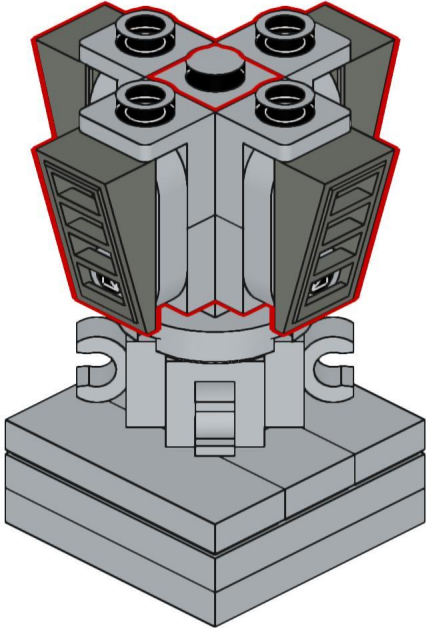
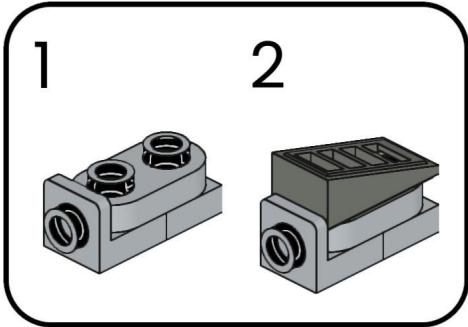

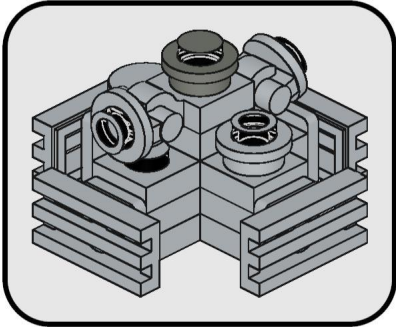
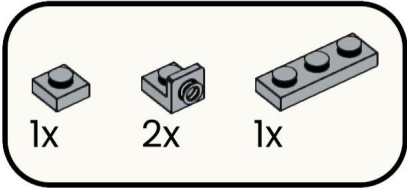

9

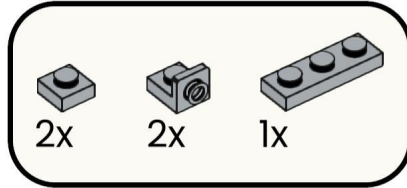
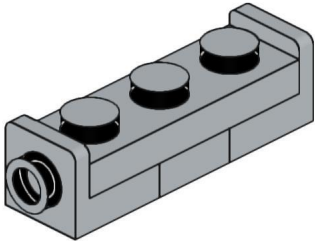

10

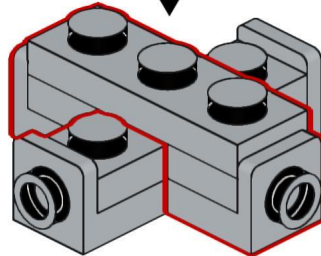
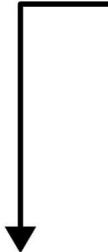
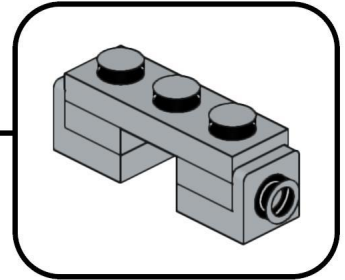

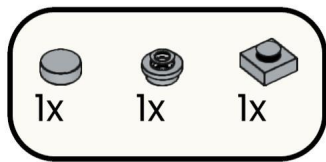

11

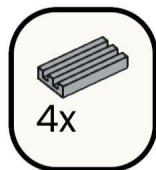
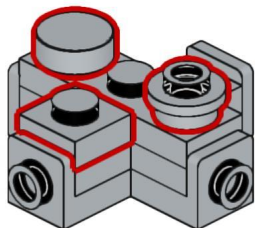

12

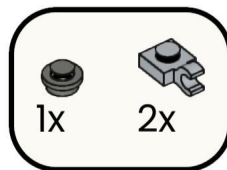
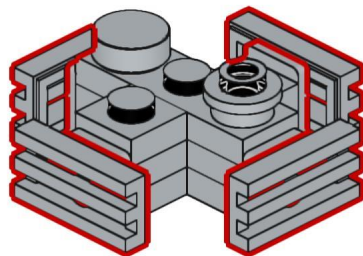

13

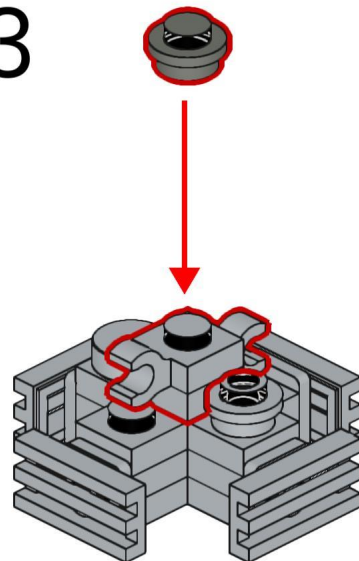



14

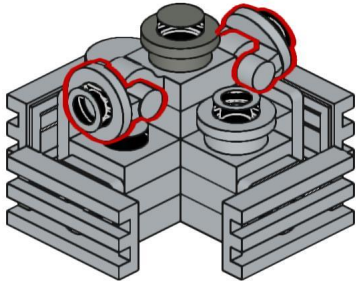

15

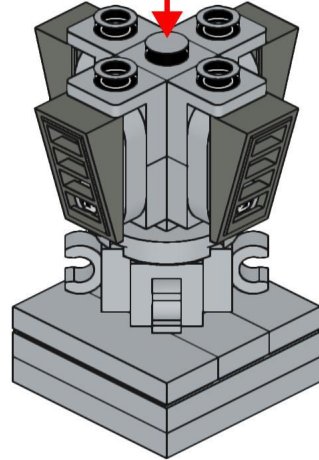
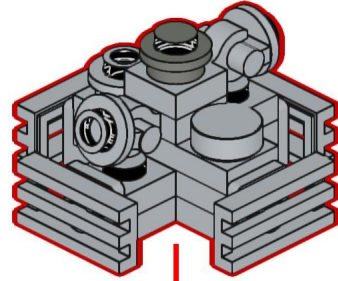

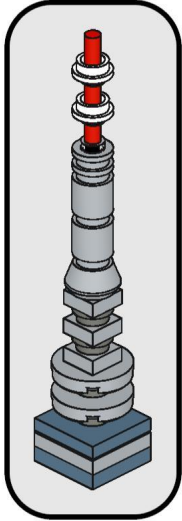
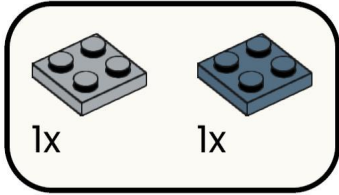

16

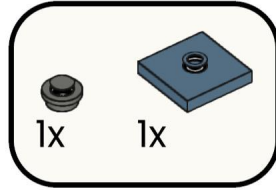
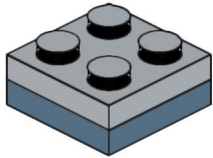

17

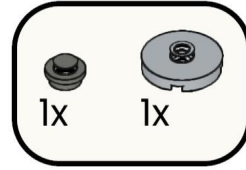
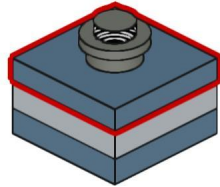

18

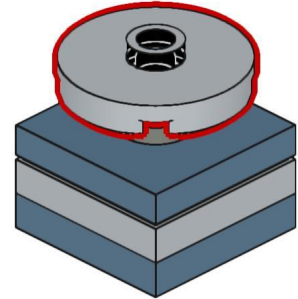

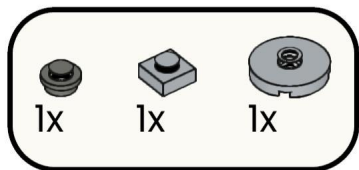

19

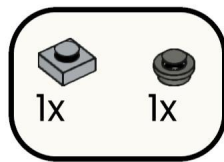
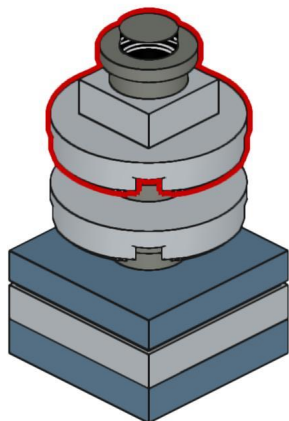

20

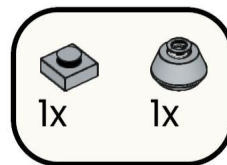
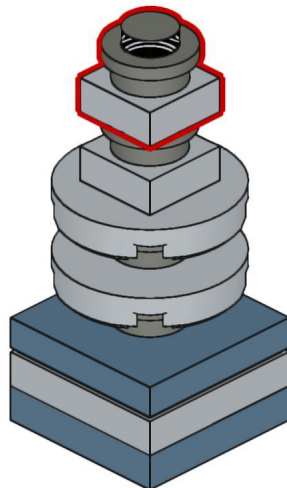

21

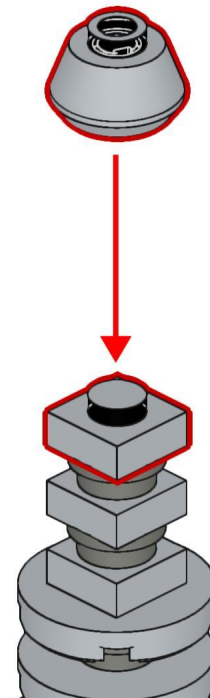



22

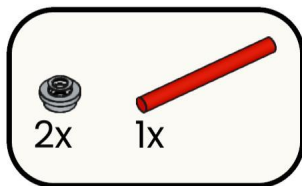
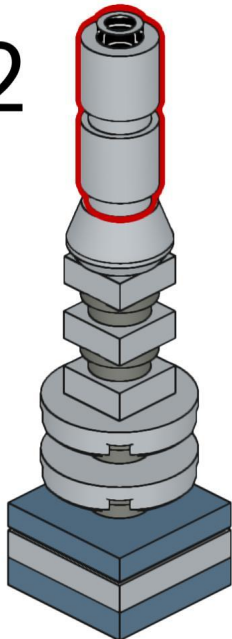

23

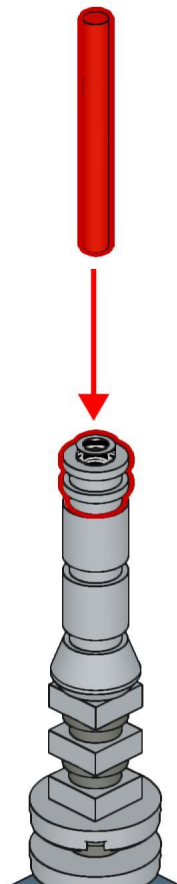

24

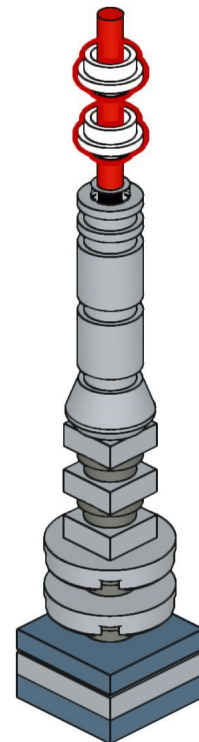

# 25

The top of the tower reaches approximately 635 meters above sea level, providing direct line-of-sight coverage over a large part of western Slovakia.

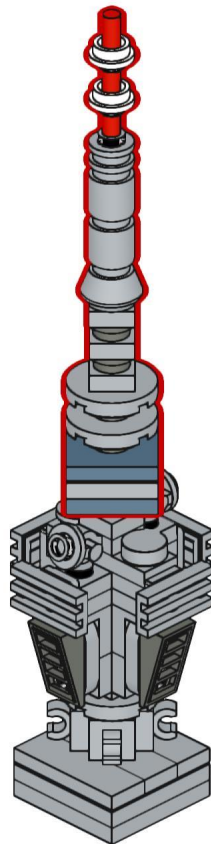

Vrchol veže dosahuje výšku približne 635 metrov nad morom, čo umožňuje pokrytie priamou viditeľnosťou veľkej časti západného Slovenska.

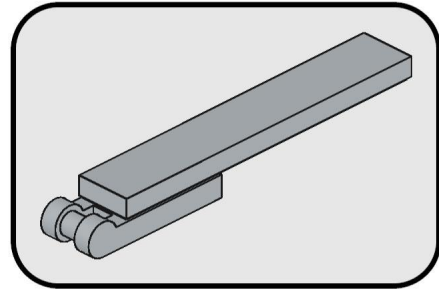
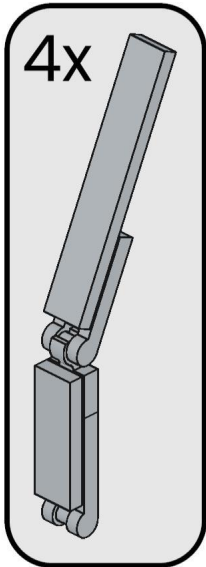
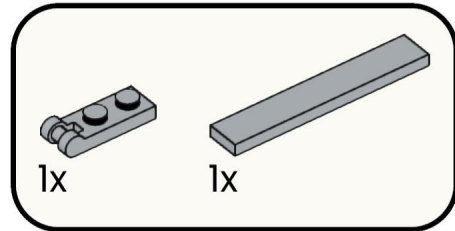
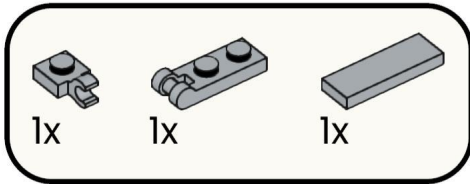

26

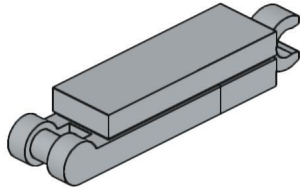

27

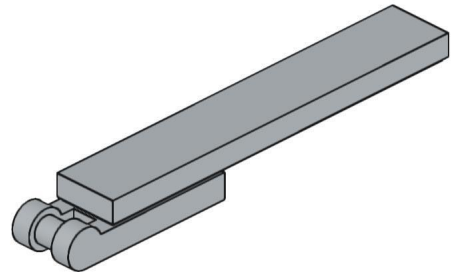

28

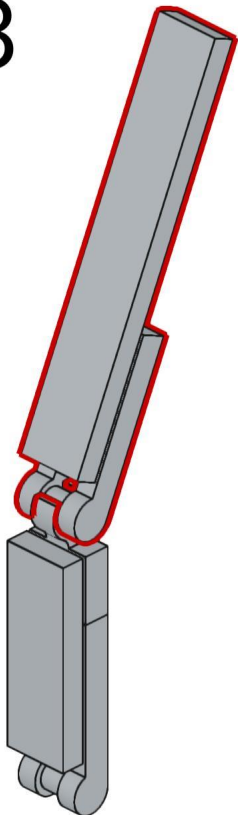

29

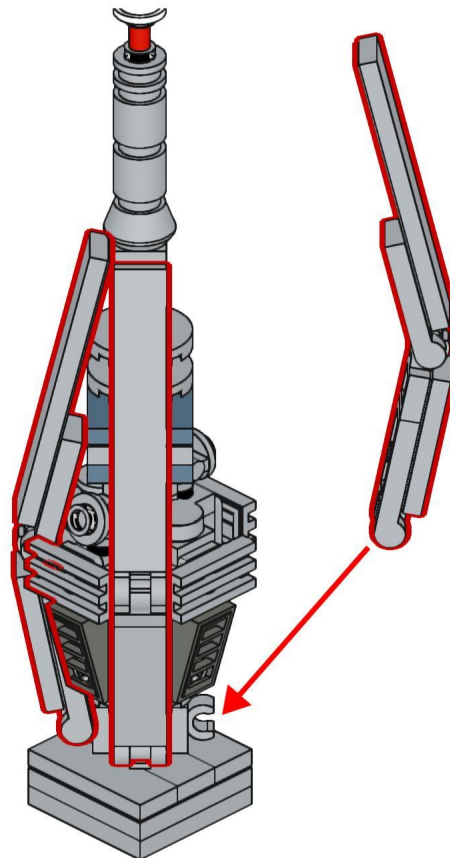

Veža vysiela televízne a rozhlasové signály nepretržite od polovice 70. rokov a slúži slovenským aj regionálnym vysielateľom.

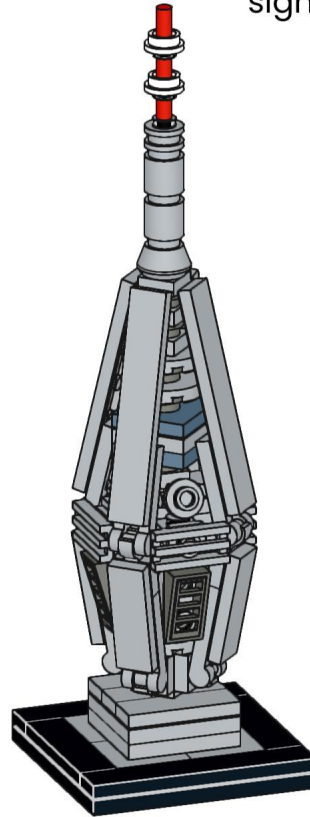

The tower has transmitted television and radio signals continuously since the mid-1970s, serving both Slovak and regional broadcasters.



2x



2x



1x



5x



4x



2x



1x



12x



3x



4x



2x



1x



2x



8x



6x



1x

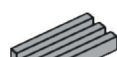

4x

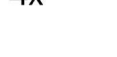

4x



4x



2x

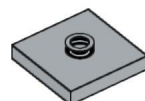

4x

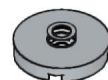

3x



1x

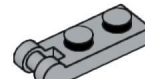

8x

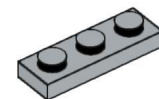

2x

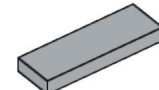

6x

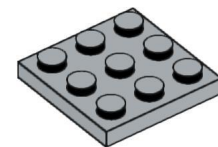

2x



4x



2x



1x

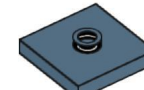

1x

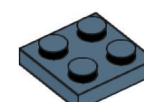

1x



# LEAVE A REVIEW!

We'd love to hear your thoughts!

# NAPÍŠTE RECENZIU!

Radi si prečítame Váš názor!

---

Take a look at our other MOC Kits! | Pozrite si naše ďalšie MOC stavebnice!

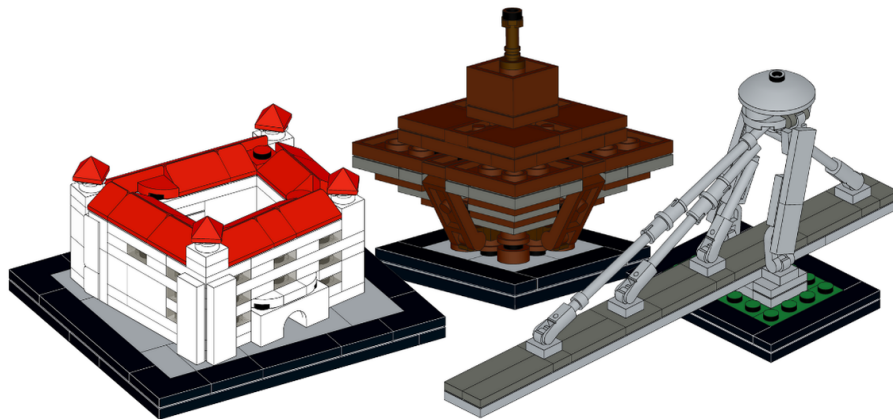
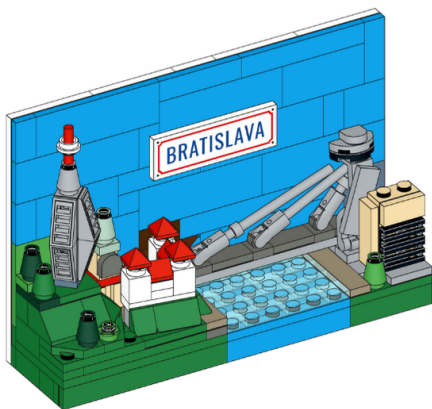

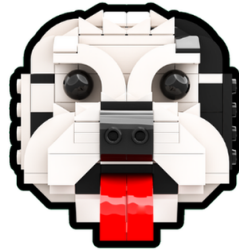

Building instructions and model designed by The Bobby Brix Channel.  
For questions or support, visit [www.bobbybrix.com](http://www.bobbybrix.com)

© 2025 The Bobby Brix Channel (SREDA s.r.o.) – All rights reserved.