

BOBBY BRIX

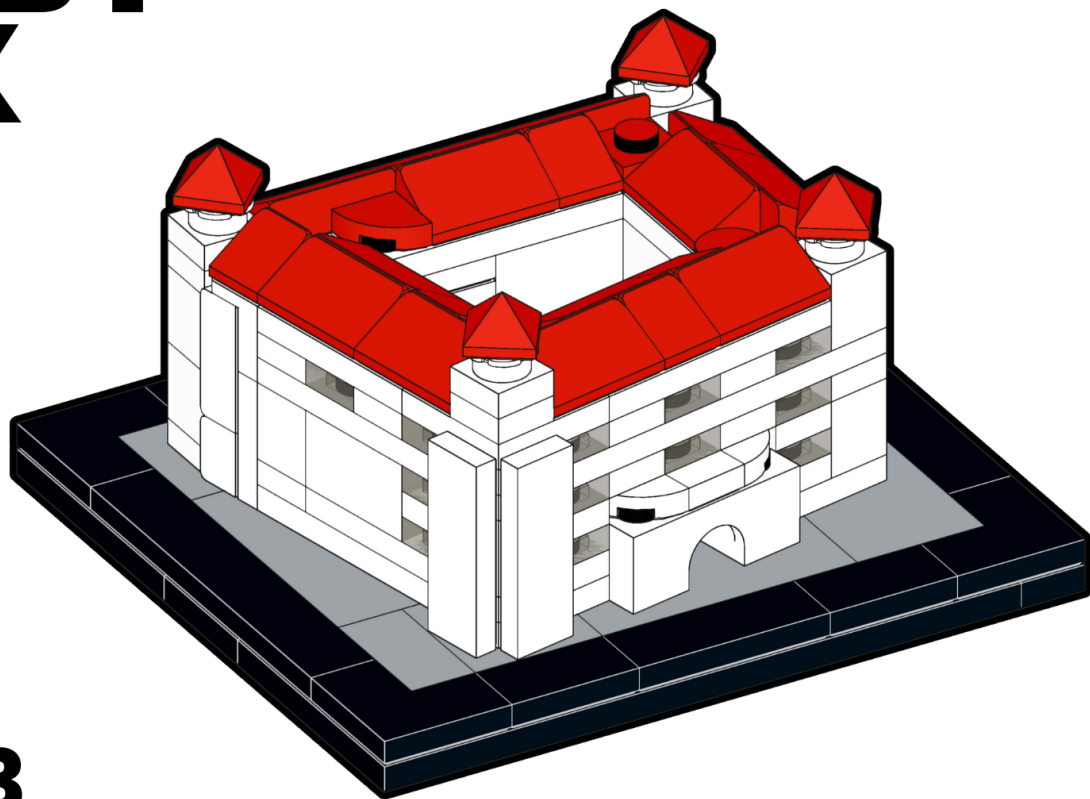

BB-003
MOC #0326

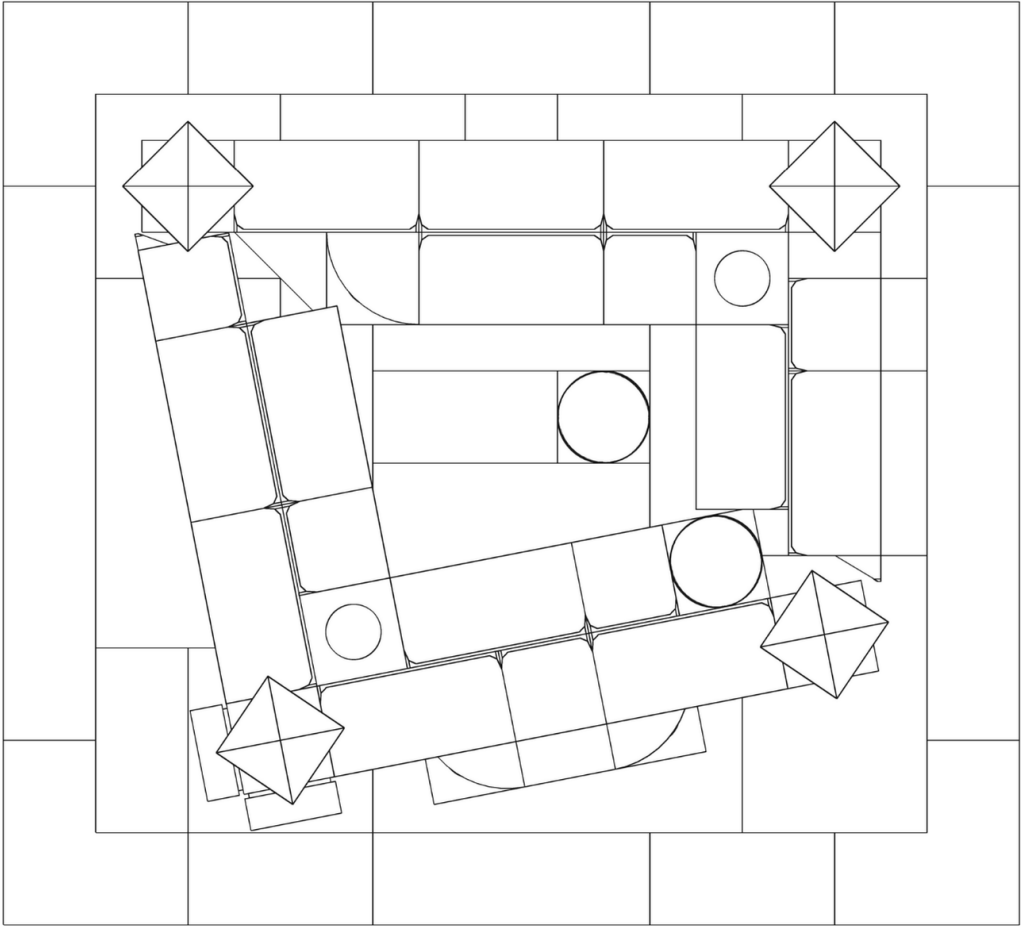

BRATISLAVSKÝ HRAD

— BRATISLAVA CASTLE —

Bratislavský hrad je výrazná dominanta, ktorá stojí na rieke Dunaj v hlavnom meste Slovenska.

Miesto bolo osídlené už v praveku a už v 9. storočí tu stálo opevnenie. Hrad zohrával dôležitú úlohu v Uhorskom kráľovstve, slúžil ako kráľovské sídlo a význam získal aj za vlády cisárkovej Márie Terézie v 18. storočí.

Jeho obdĺžnikový tvar so štyrmi nárožnými vežami je ľahko rozpoznateľný, pričom najväčšia je Korunovačná veža. Z hradných terás sa naskytajú panoramatické výhľady na Bratislavu, rieku Dunaj a prilahlé časti Rakúska a Maďarska za jasného počasia.

Bratislava Castle is a dominant landmark that stands on the Danube River in the capital of Slovakia. The site has been settled since prehistoric times, and a stronghold stood here as early as the 9th century. The castle played a major role in the Kingdom of Hungary, serving as a royal residence and later gaining prominence under Queen Maria Theresa in the 18th century.

Its rectangular shape with four corner towers is instantly recognizable, with the Crown Tower being the largest. From its terraces, the castle offers panoramic views over Bratislava, the Danube river, as well as neighboring Austria and Hungary on clear days.

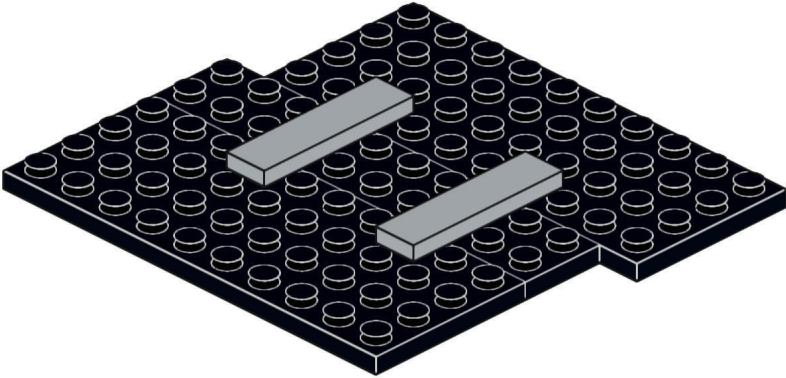
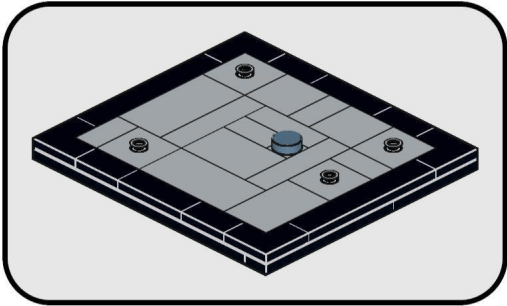
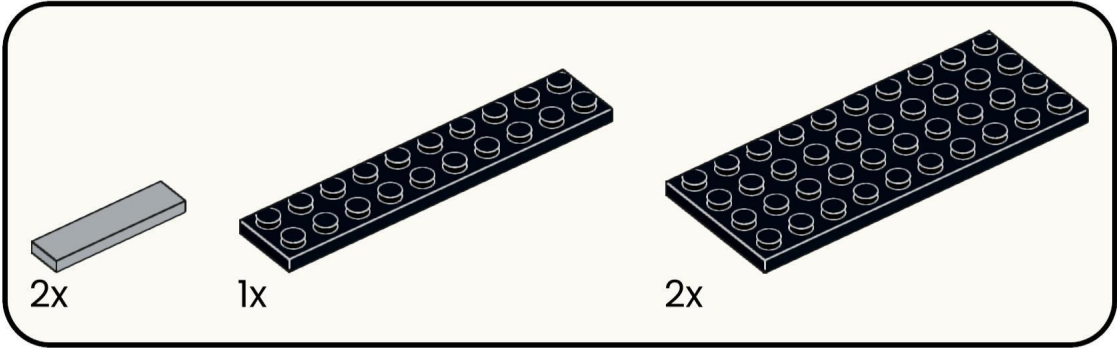

1

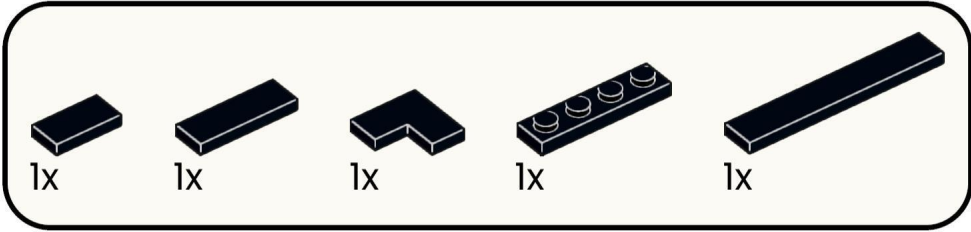

2

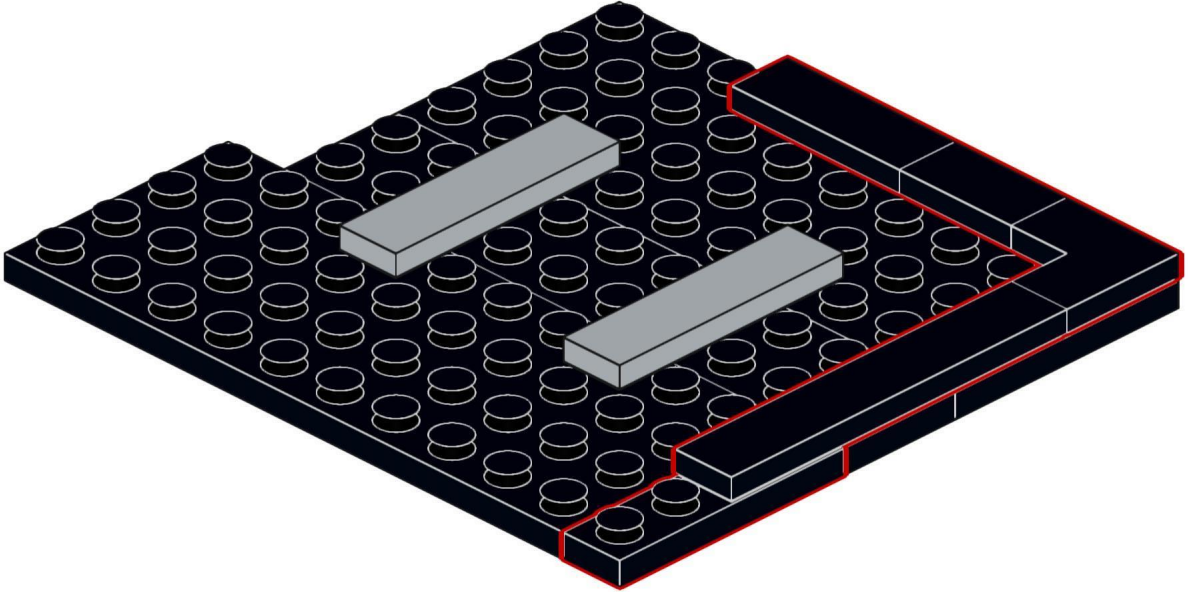

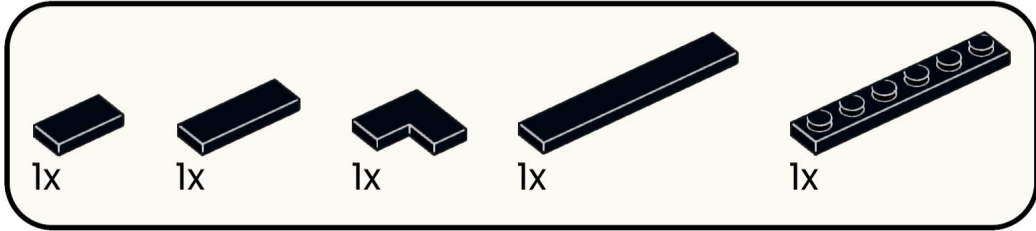

3

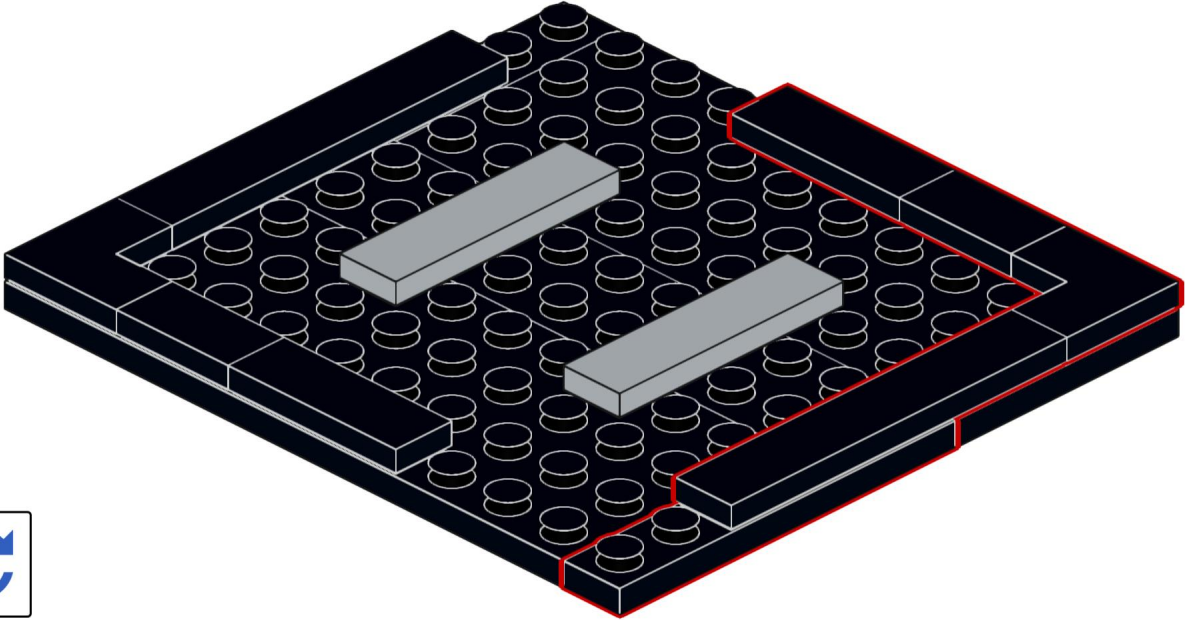

4

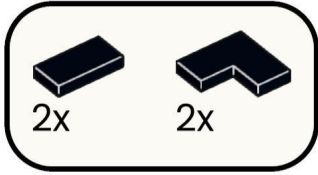

4

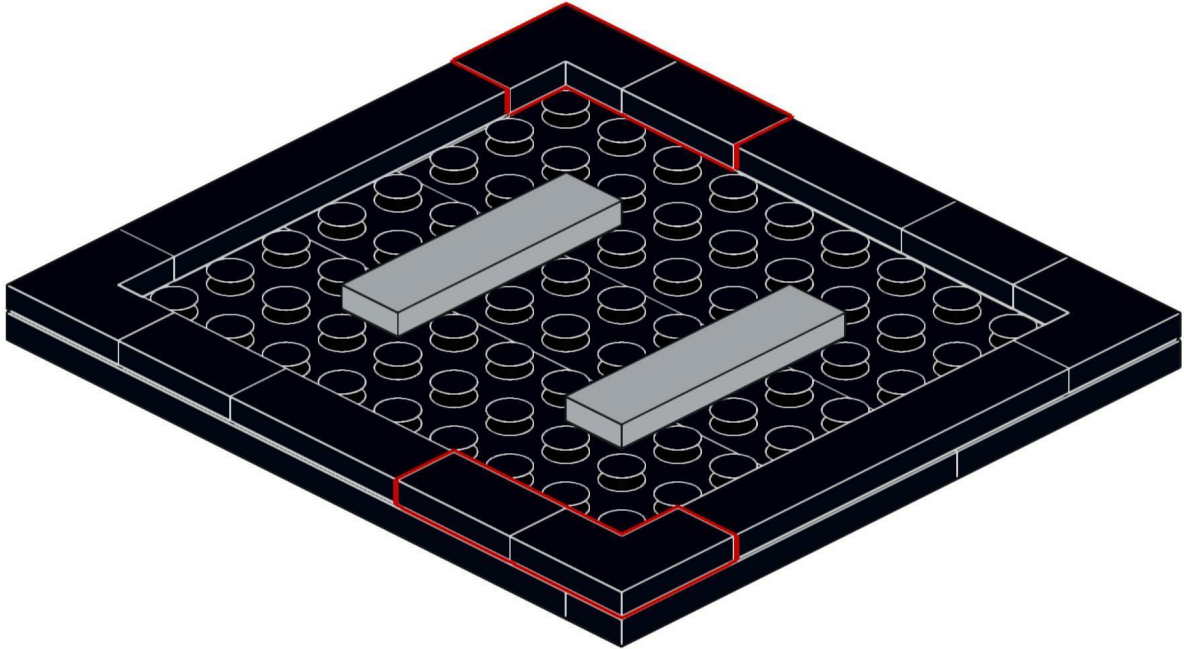

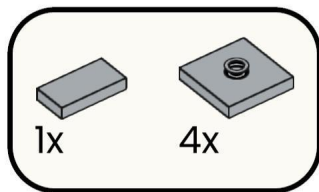

5

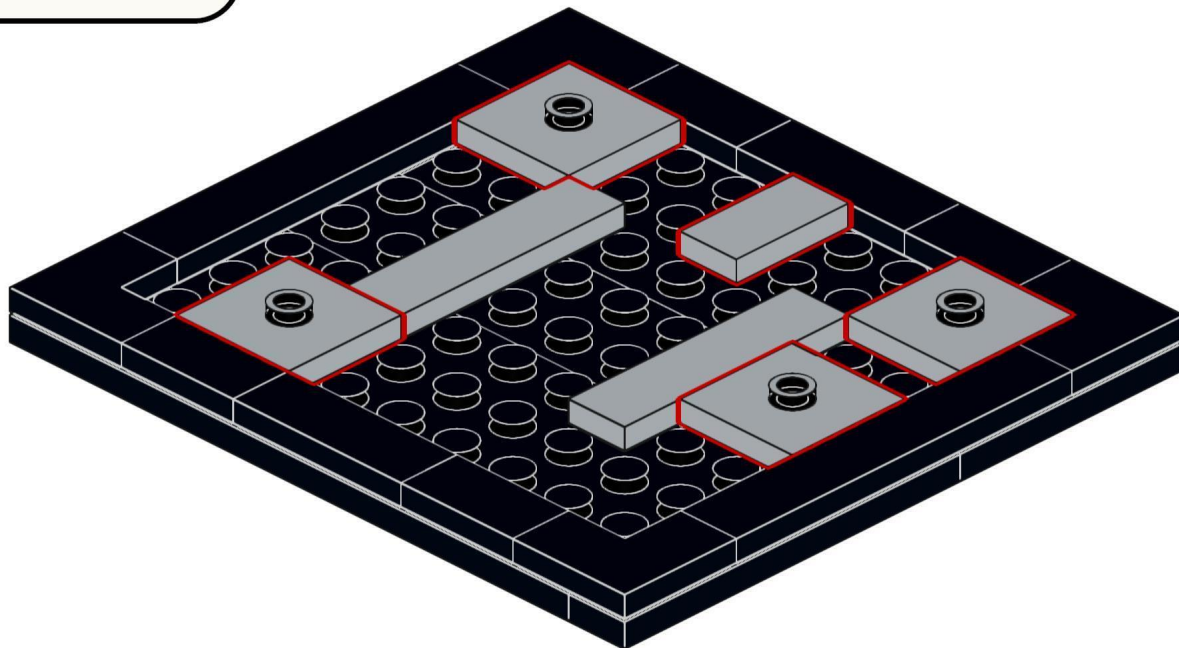

6

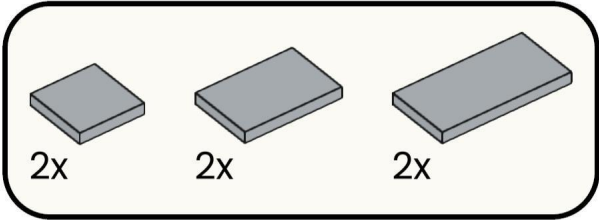

6

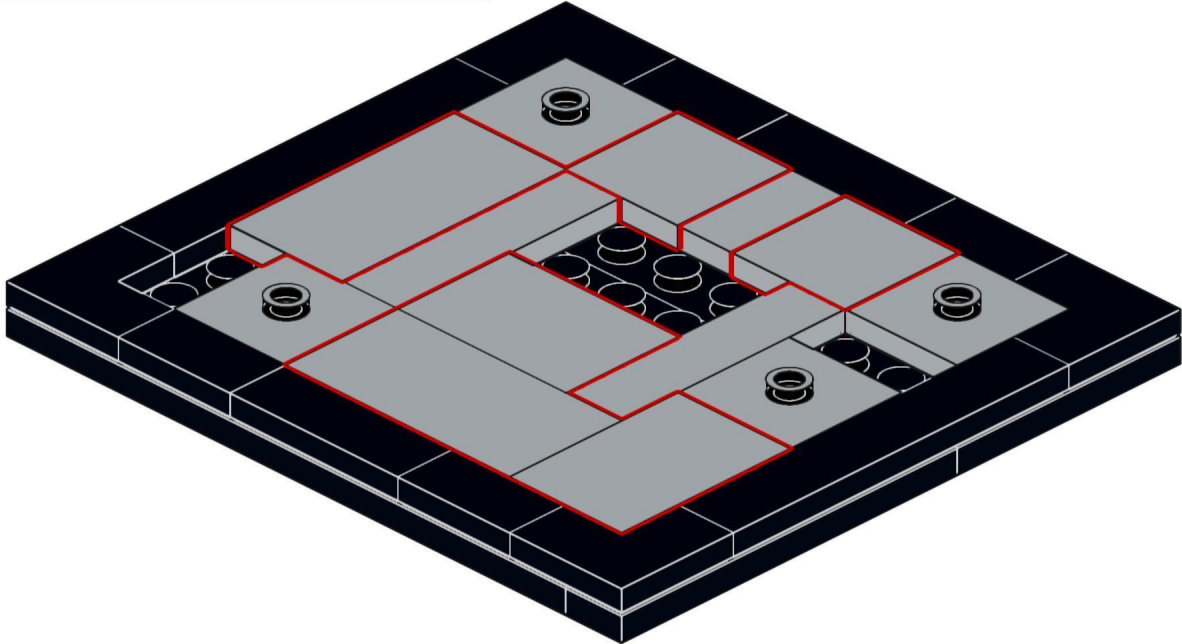

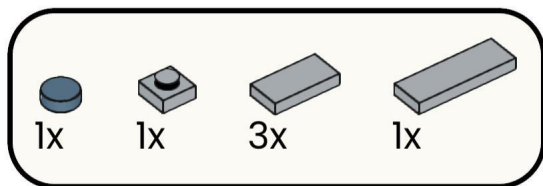

Hrad má nádvorie so studňou z 15. storočia, ktorá je hlboká približne 85 metrov.

7

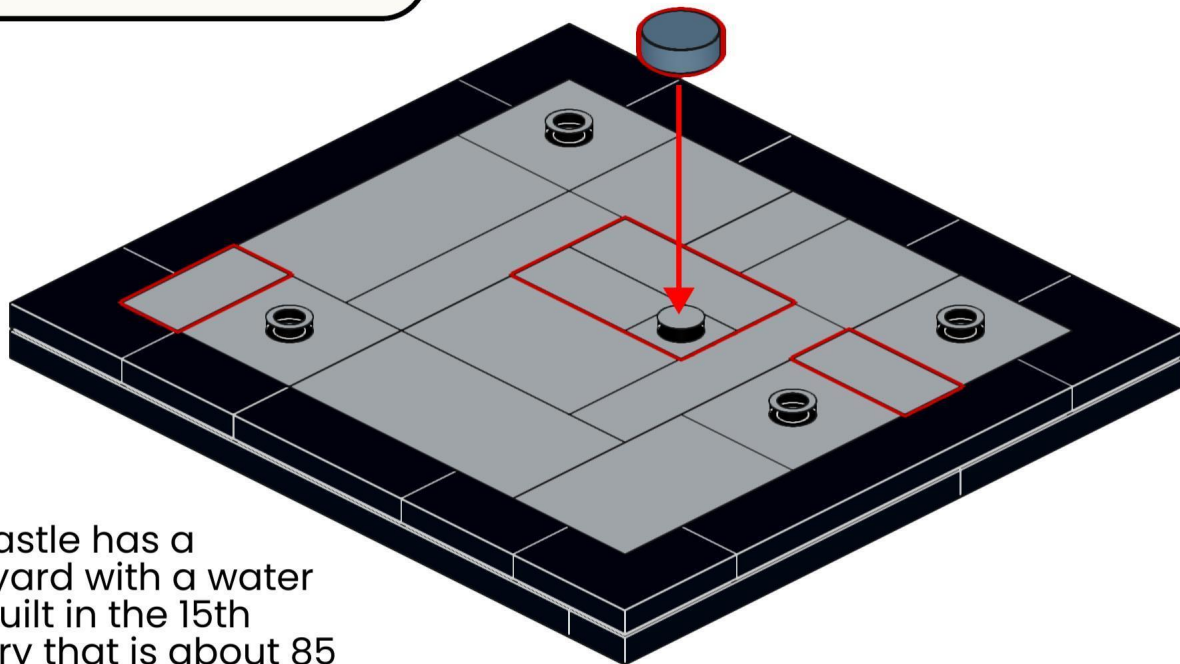

The castle has a courtyard with a water well built in the 15th century that is about 85 metres deep.

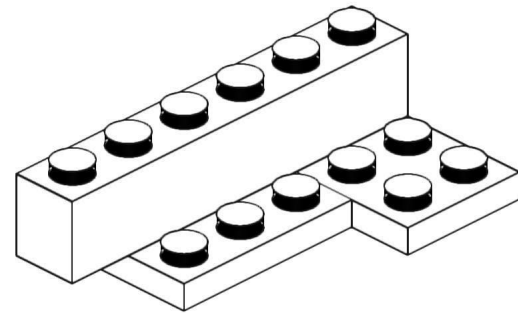
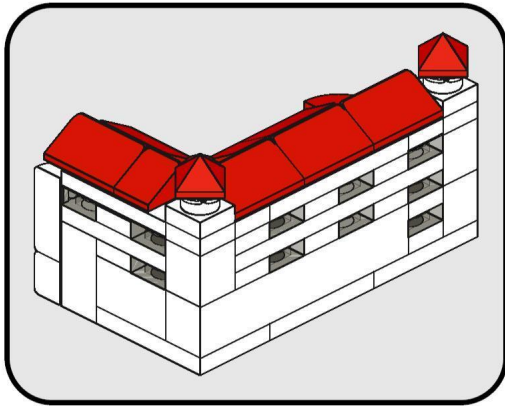
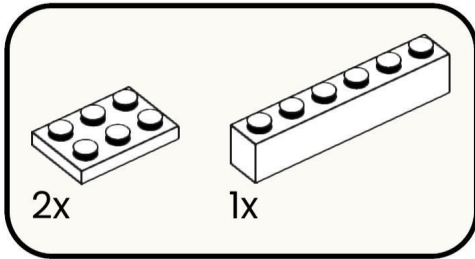

8

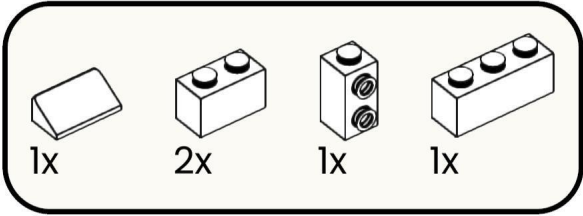

9

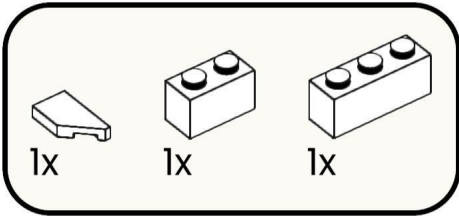
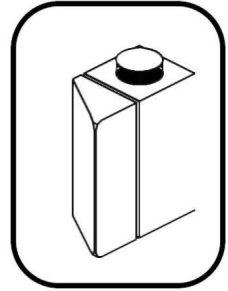
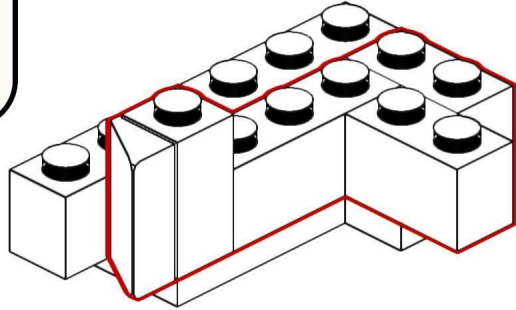

10

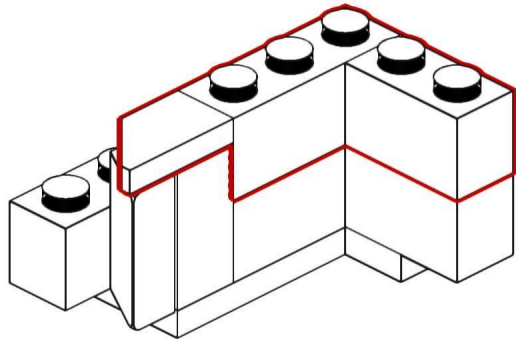

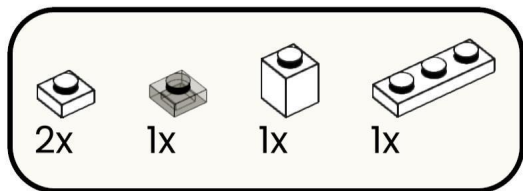

11

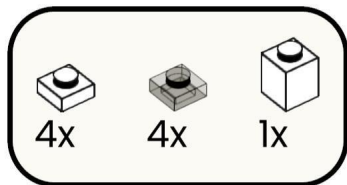
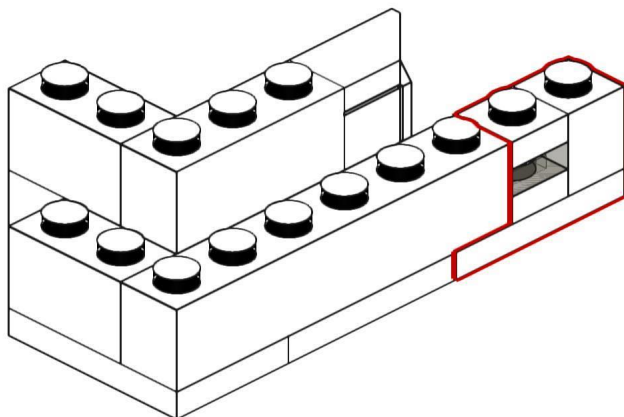

12

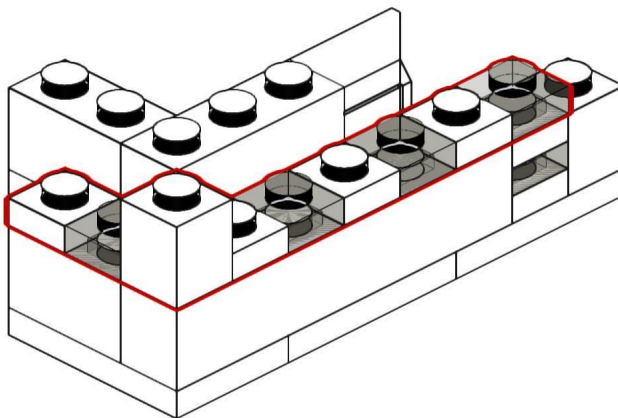

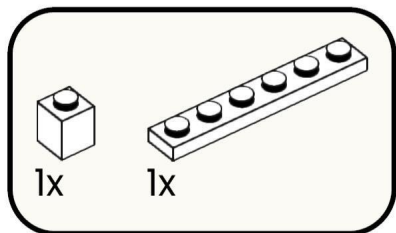

13

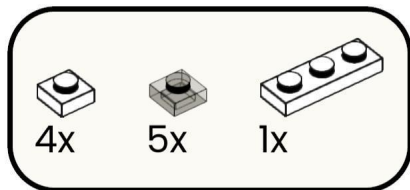
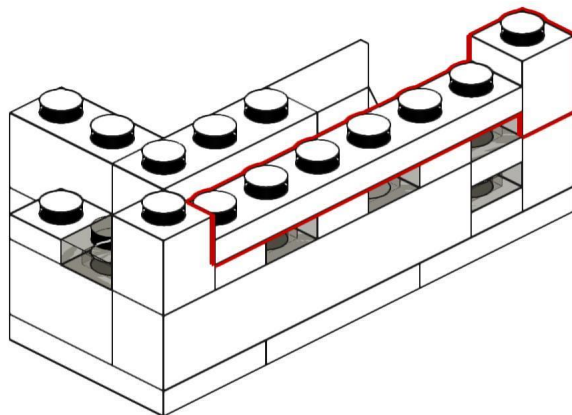

14

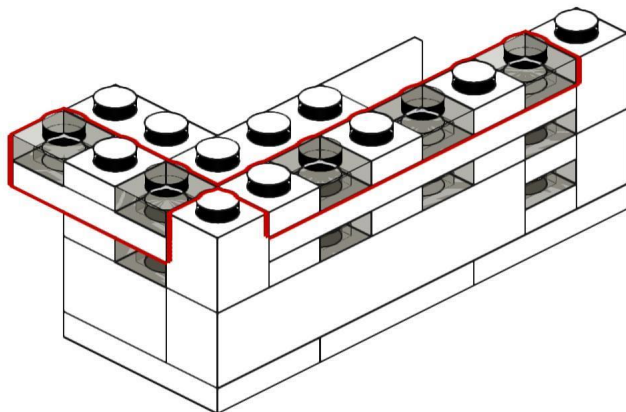

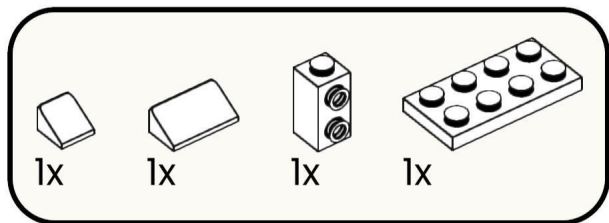

15

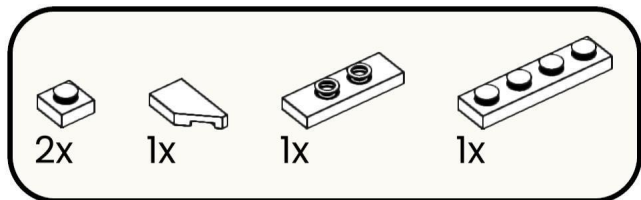
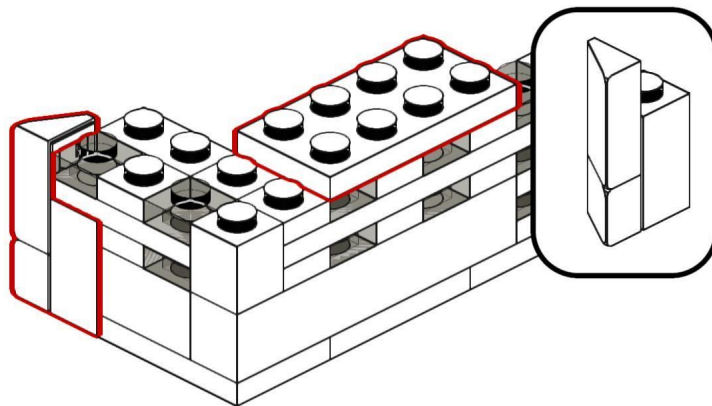

16

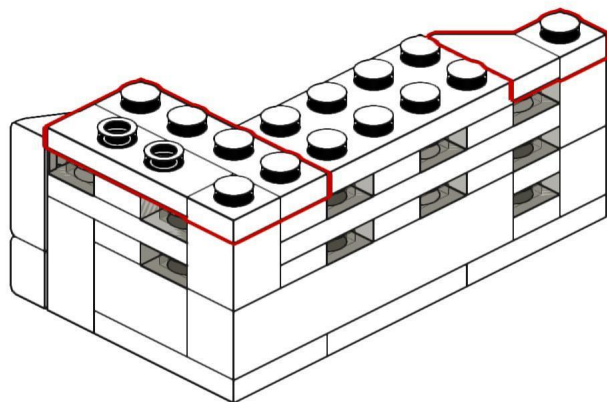

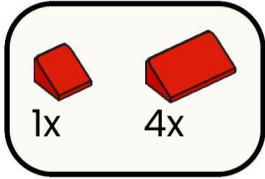

17

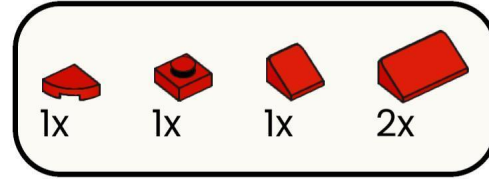
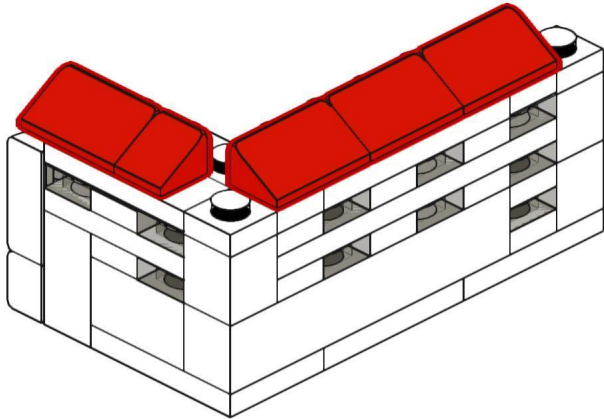

18

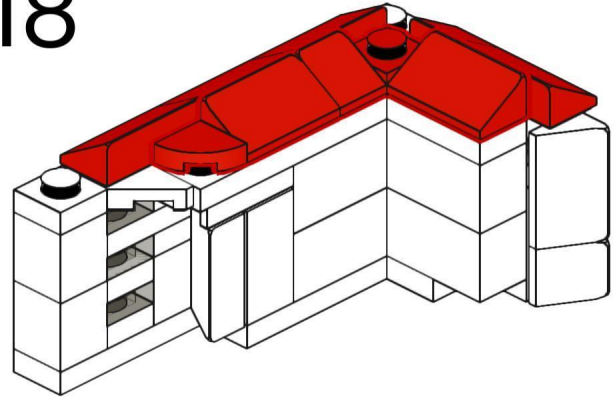

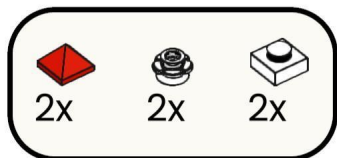

19

Hrad je sídlom Slovenského národného múzea - Múzea histórie, ktoré uchováva viac ako 250 000 predmetov dokumentujúcich dejiny Slovenska.

The castle is home to the Slovak National Museum - Museum of History, which holds over 250,000 items documenting the history of Slovakia.

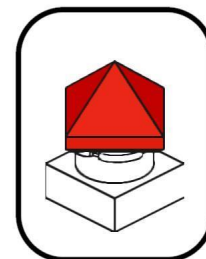

2x

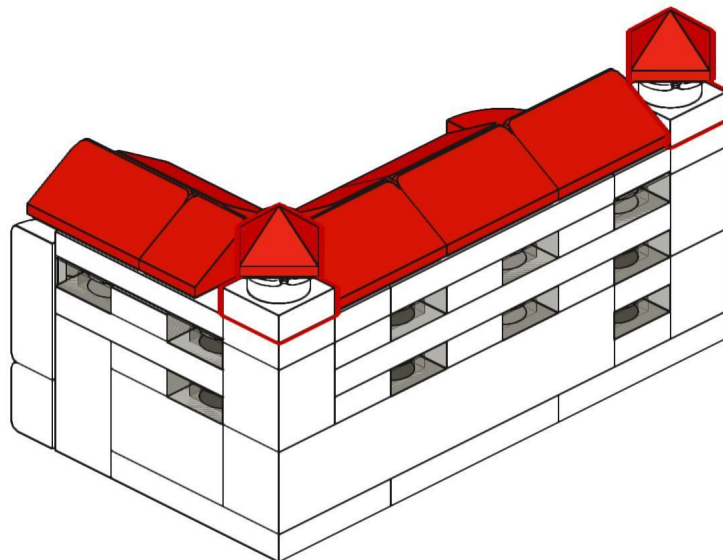

20

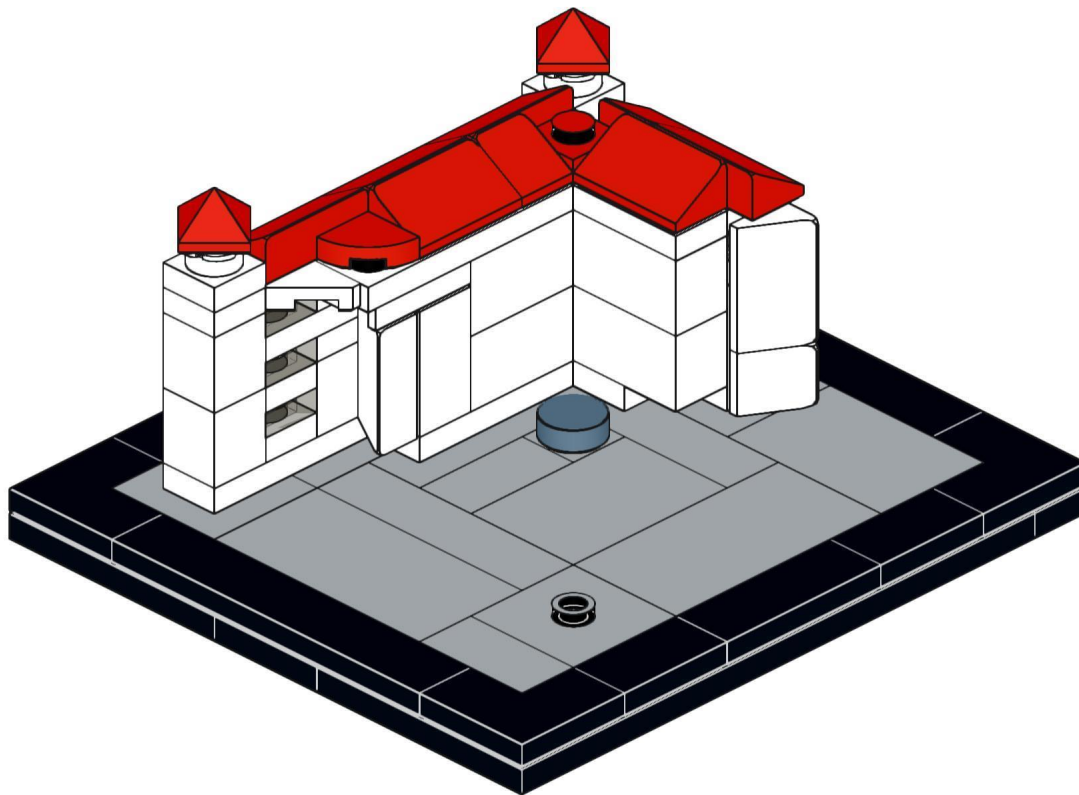

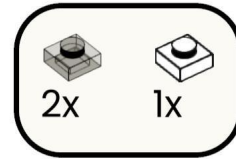
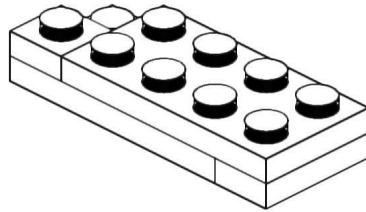
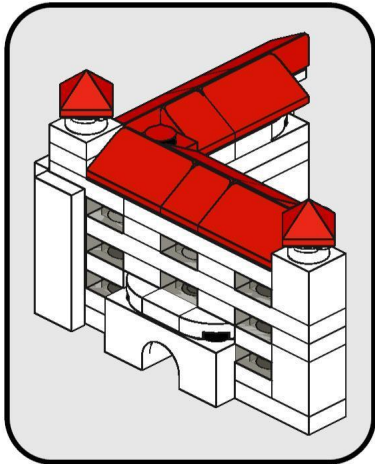
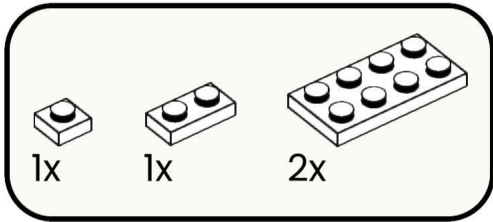

22

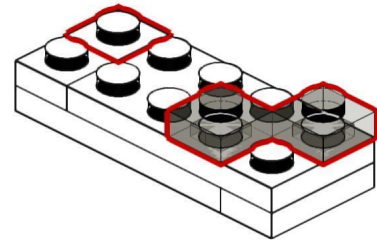

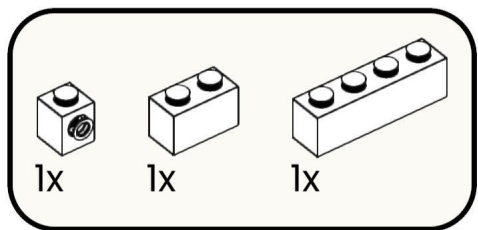

23

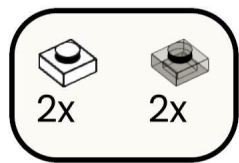
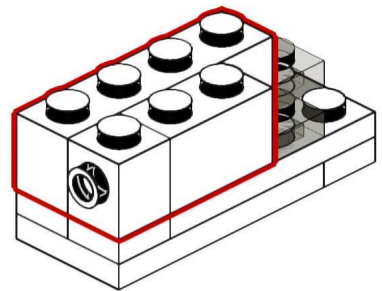

24

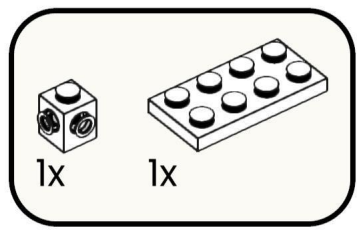
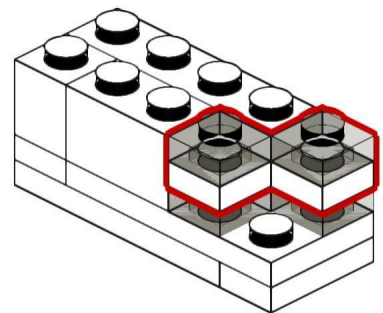

25

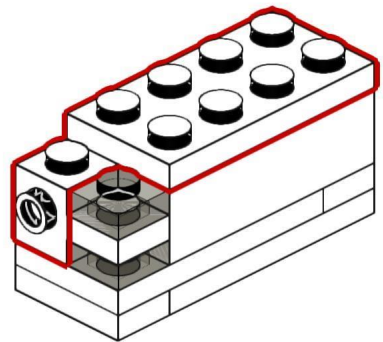

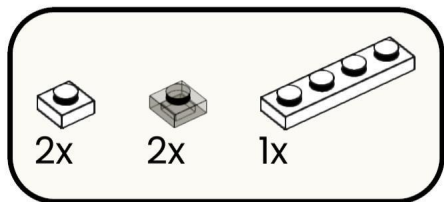

26

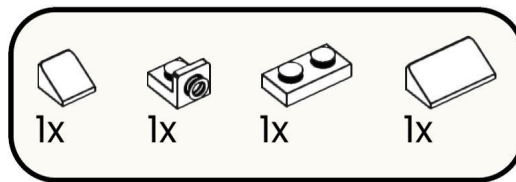
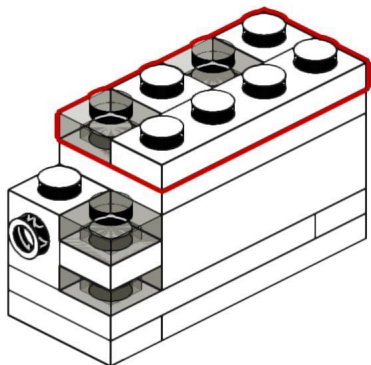

27

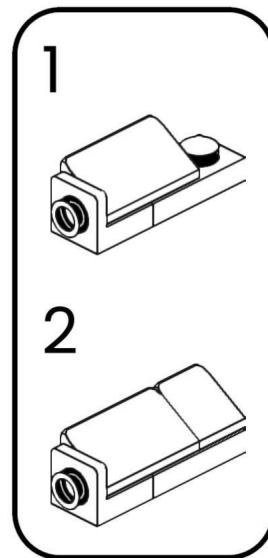
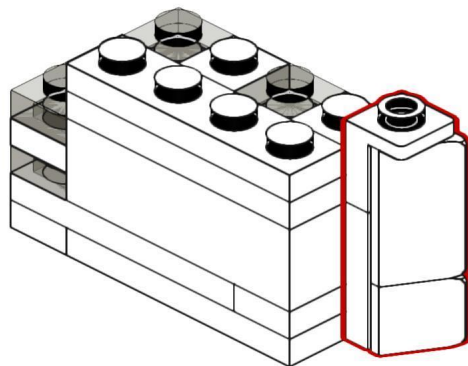

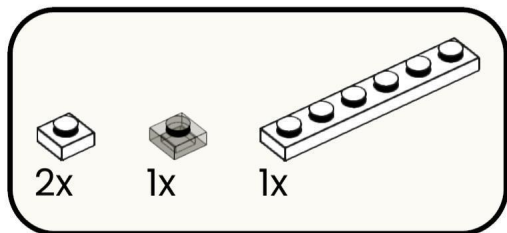

V roku 1811 hrad zničil obrovský požiar, po ktorom zostal v ruinách až do svojej prestavby v polovici 20. storočia.

In 1811, a huge fire destroyed the castle, leaving it in ruins until it was rebuilt in the mid-20th century.

28

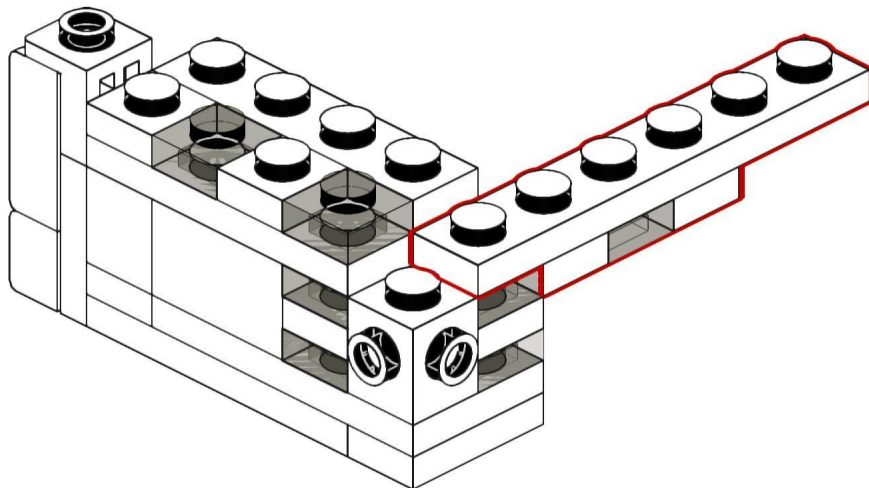

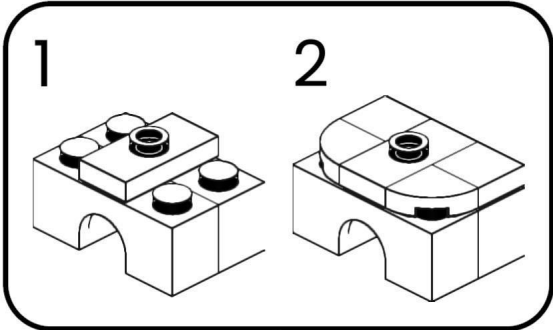
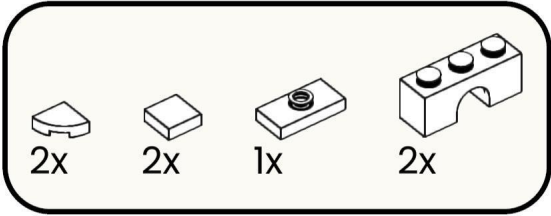

29

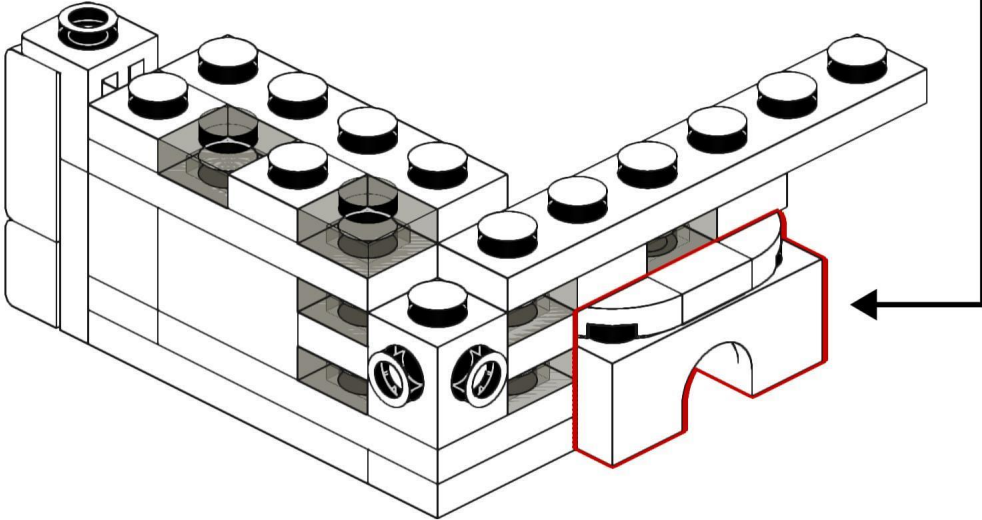

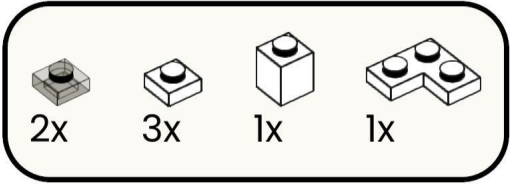

30

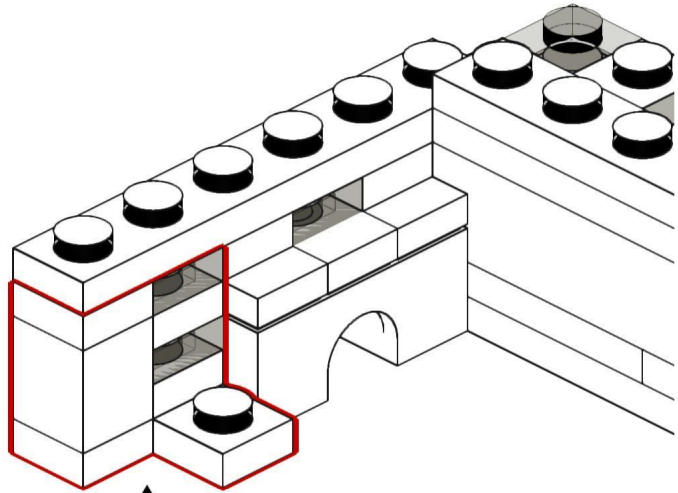
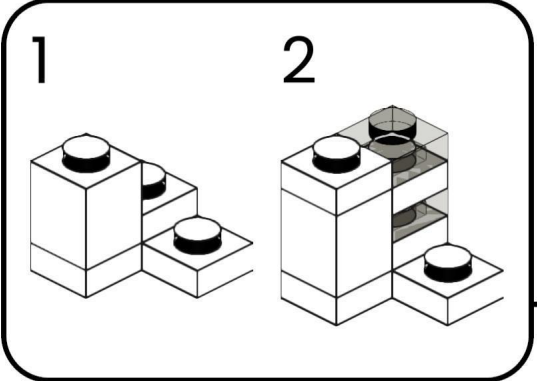

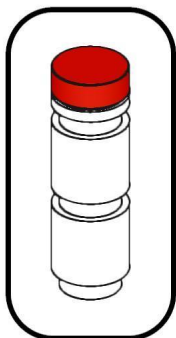
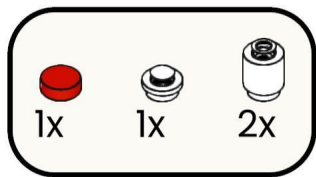

31

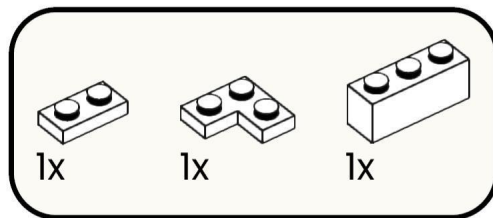
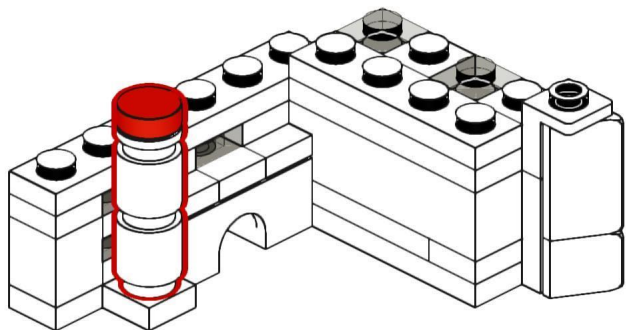

32

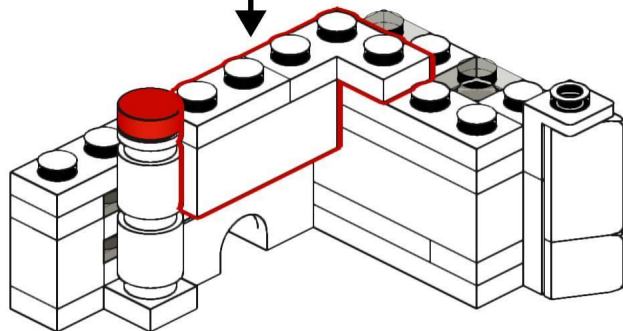
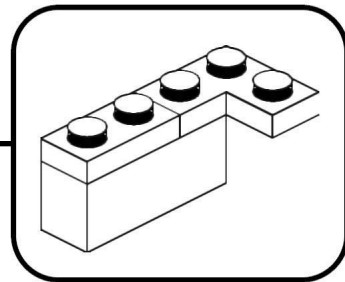

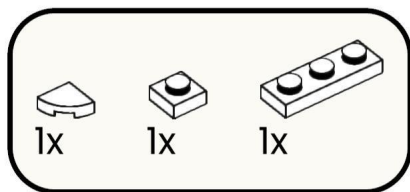

33

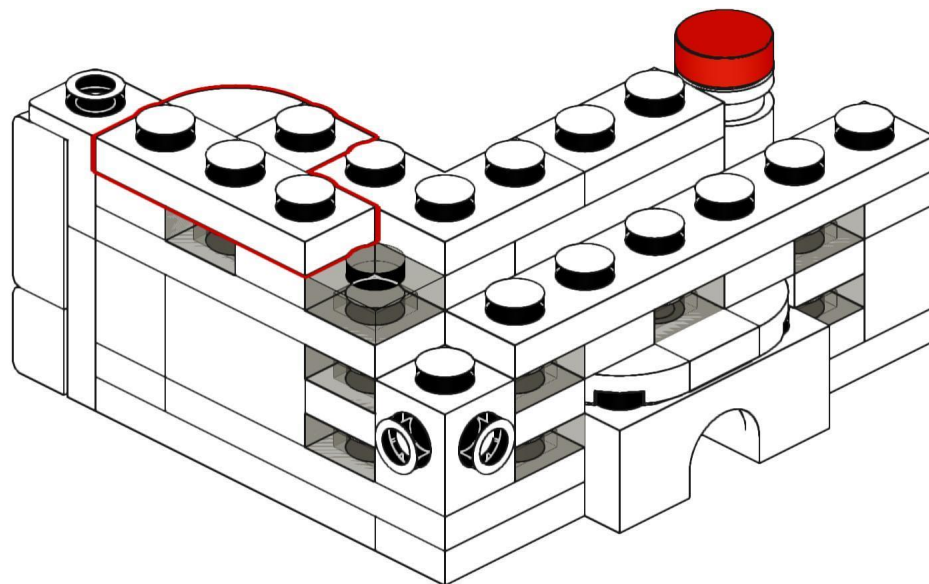

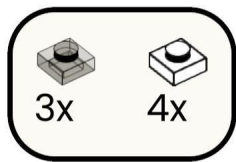

34

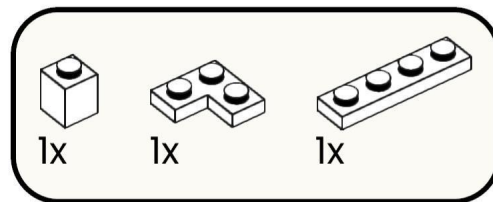
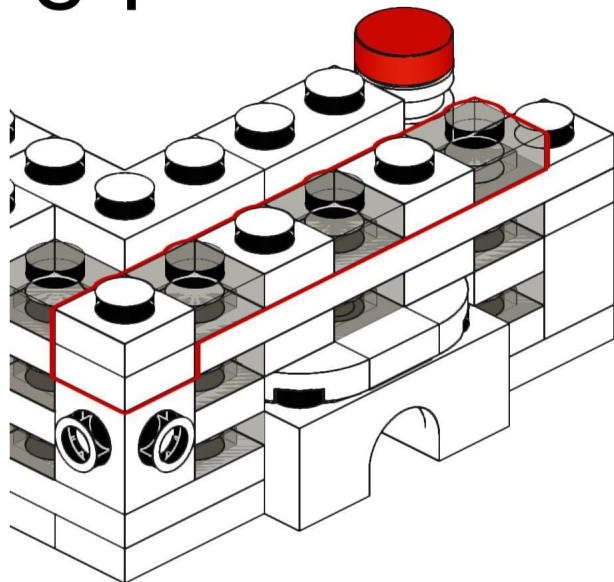

35

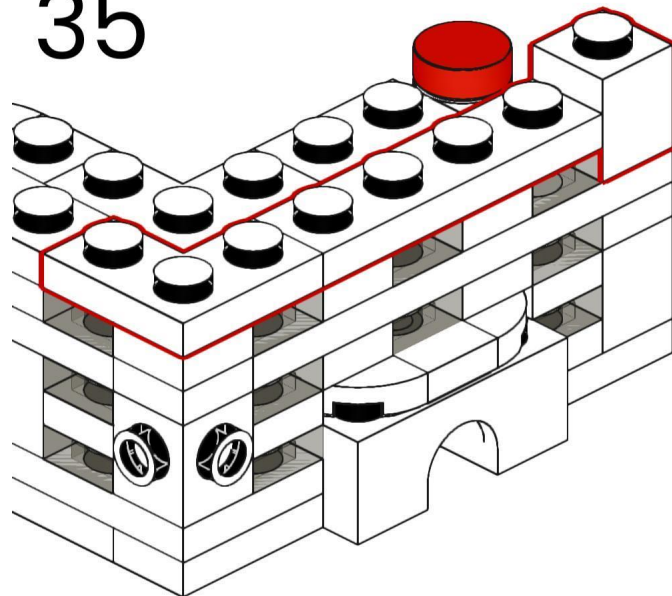

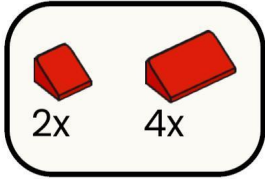

36

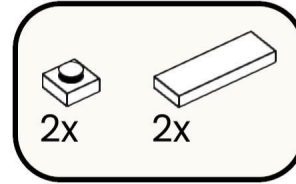
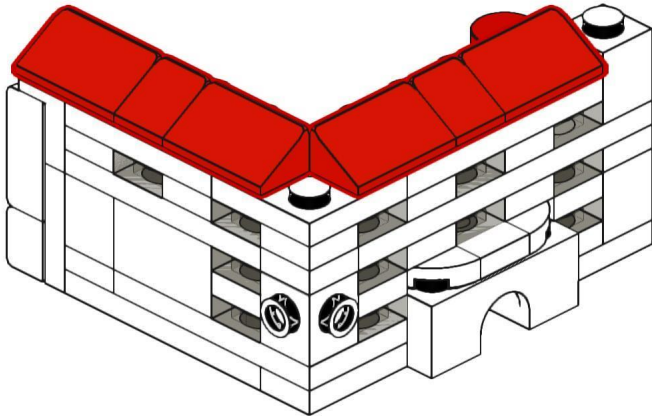

37

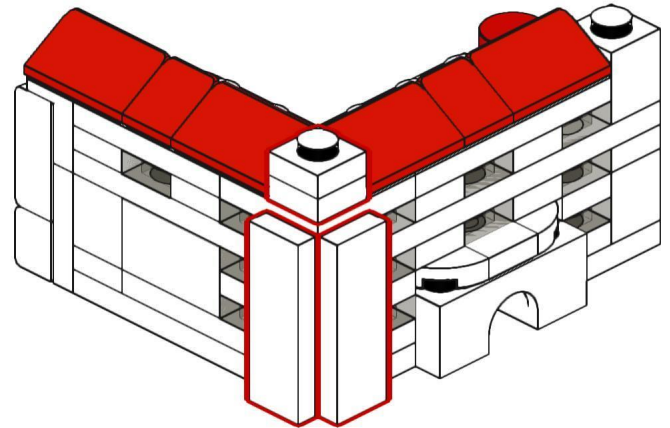

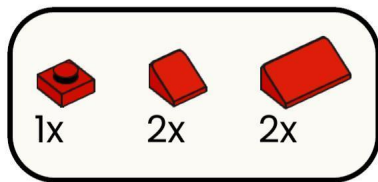

38

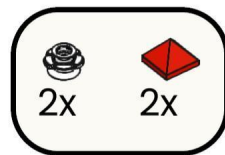
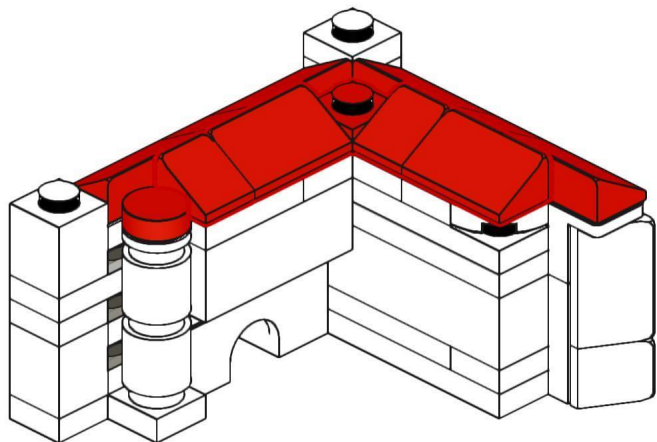

39

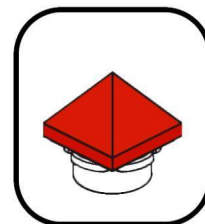

2x

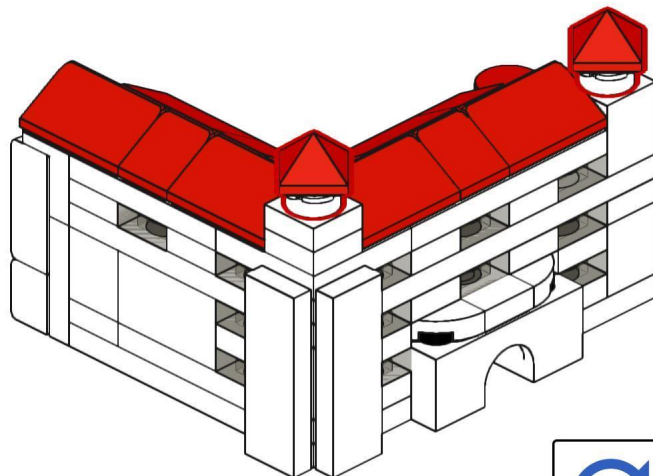

40

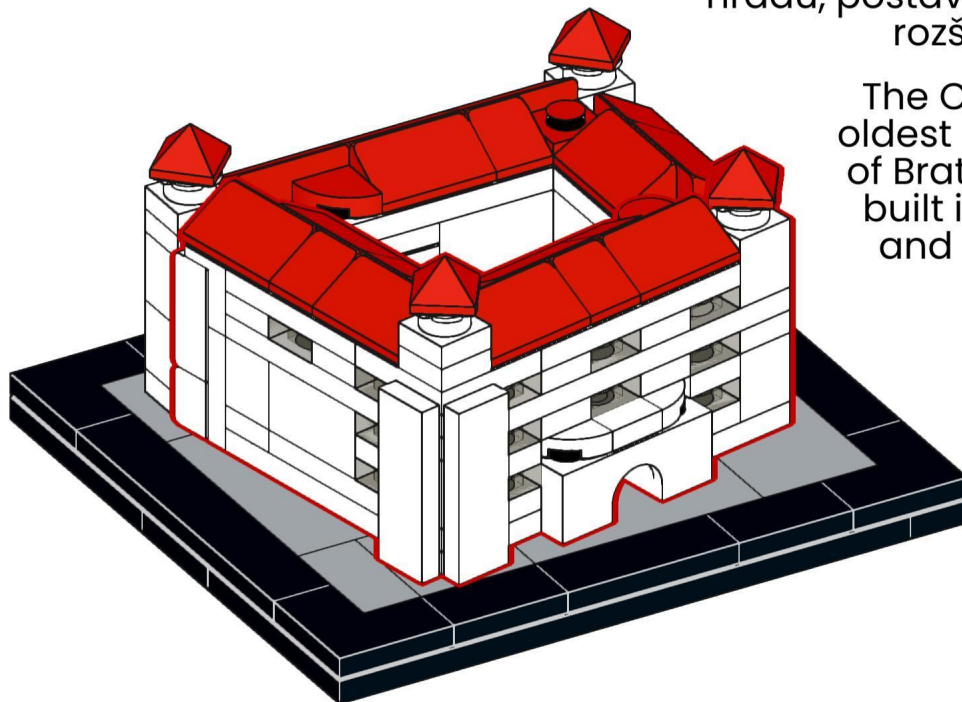

Korunovačná veža je najstaršia a najväčšia veža Bratislavského hradu, postavená v 13. storočí a rozšírená v 15. storočí.

The Crown Tower is the oldest and largest tower of Bratislava Castle, first built in the 13th century and later expanded in the 15th century.

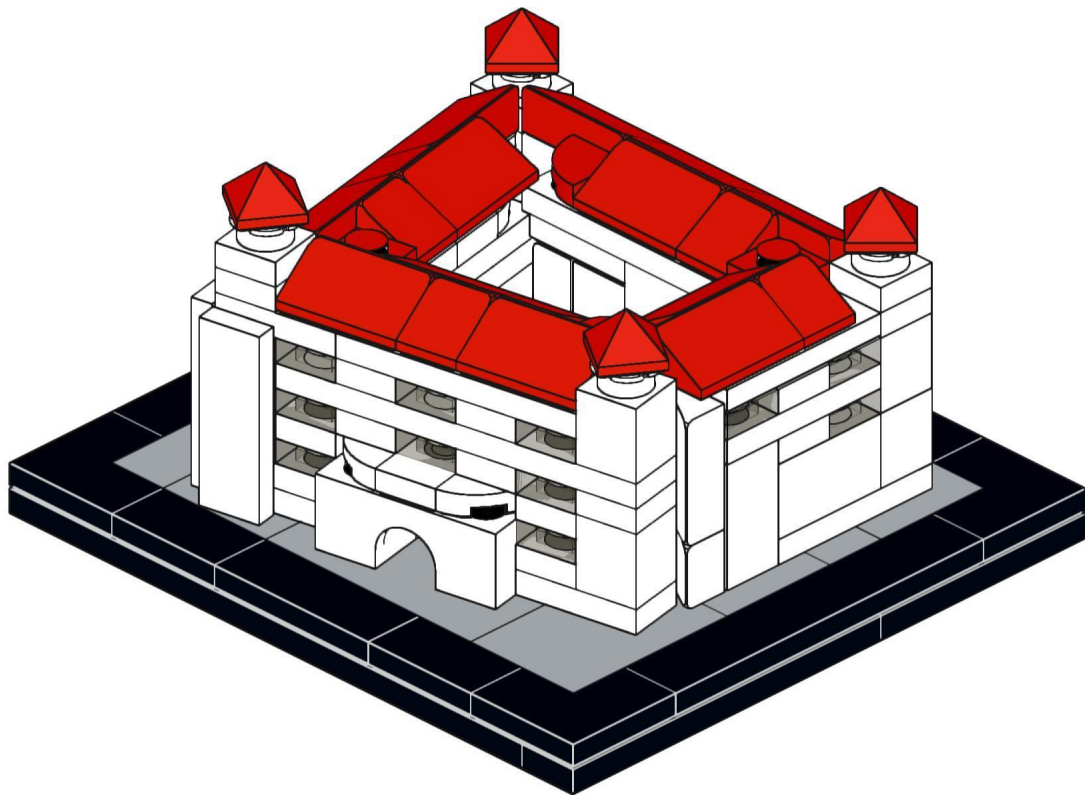



4x



4x



2x



1x



2x



1x



1x



2x



1x

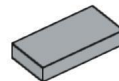

4x

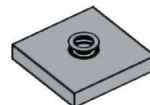

4x

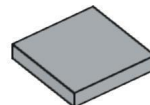

2x

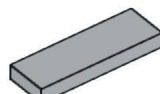

1x

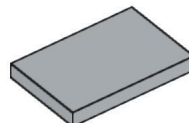

2x

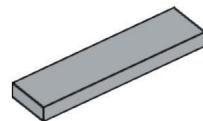

2x

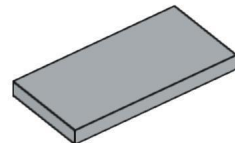

2x



2x



3x



1x



4x



32x



1x

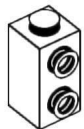

2x

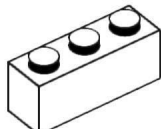

3x

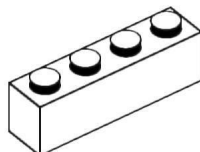

1x



1x



22x



2x



1x

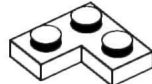

3x

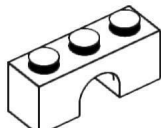

2x

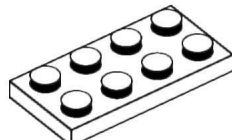

4x



1x



1x



1x

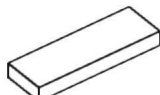

2x

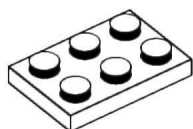

2x

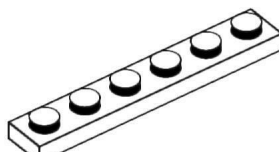

2x



2x



2x

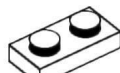

3x

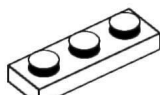

3x

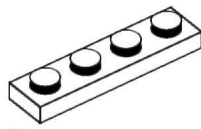

3x

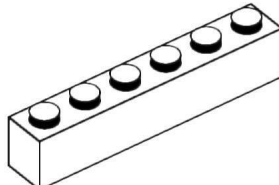

1x



6x



5x



3x

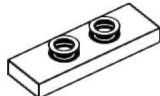

1x



4x

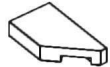

2x

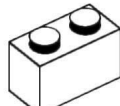

4x



12x



1x



LEAVE A REVIEW!

We'd love to hear your thoughts!

NAPÍŠTE RECENZIU!

Radi si prečítame Váš názor!

Take a look at our other MOC Kits! | Pozrite si naše ďalšie MOC stavebnice!

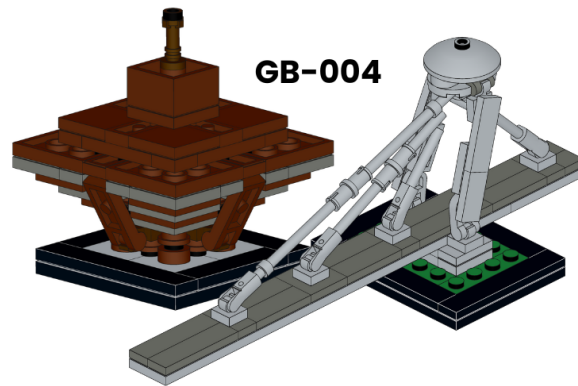
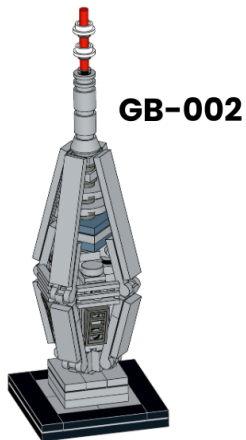
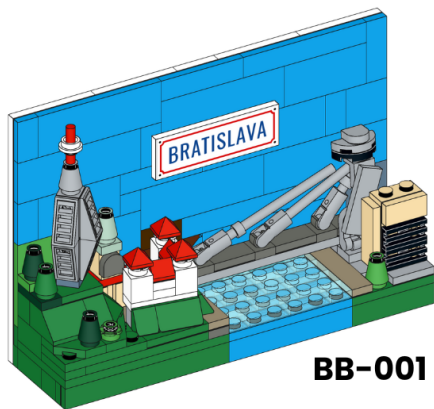

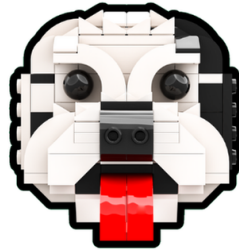

Building instructions and model designed by The Bobby Brix Channel.
For questions or support, visit www.bobbybrix.com

© 2025 The Bobby Brix Channel (SREDA s.r.o.) – All rights reserved.